

KRAMER



USER MANUAL

MODEL:

VP-778

Presentation Matrix Switcher/Dual Scaler



VP-778 Quick Start Guide

This guide helps you install and use your **VP-778** for the first time.

Go to www.kramerav.com/downloads/VP-778 to download the latest user manual and check if firmware upgrades are available.

Scan for full manual

Step 1: Check what's in the box

- ✓ **VP-778** Presentation Matrix Switcher/Dual Scaler
- ✓ 1 Set of rack ears
- ✓ 4 Rubber feet
- ✓ IR remote control transmitter with batteries
- ✓ 1 Power cord
- ✓ 1 Quick start guide
- ✓ 2 DVI (M) to 15-pin HD (F) (AD-DM/GF)
- ✓ 2 DVI-A (M) to 5 BNC (F) adaptor cables (ADC-DMA/5BF-1)

Step 2: Get to know your VP-778

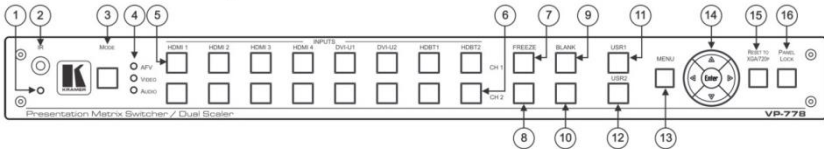

#	Feature	Function
1	IR LED	Lights red when the unit accepts IR remote commands
2	IR Receiver	Accepts IR remote commands
3	MODE Button	Select the operation mode: AFV (audio follow video), VIDEO or AUDIO
4	Mode LED indicators	Indicate the operation mode, as selected via the MODE button
5	CH 1 INPUT Selector Buttons	HDMI Press to select the HDMI input (from 1 to 4)
		DVI-U Press to select the DVI-U (universal) input (from 1 to 2)
		HDBT Press to select the HDBT input (from 1 to 2)
6	CH 2 INPUT Selector Buttons	HDMI Press to select the HDMI input (from 1 to 4)
		DVI-U Press to select the DVI-U (universal) input (from 1 to 2)
		HDBT Press to select the HDBT input (from 1 to 2)
7	CH 1 FREEZE Button	Press to freeze/unfreeze the CH 1 output video image
8	CH 2 FREEZE Button	Press to freeze/unfreeze the CH 2 output video image
9	CH 1 BLANK Button	Press to toggle between a blank screen (black) and the CH 1 display
10	CH 2 BLANK Button	Press to toggle between a blank screen (black) and the CH 2 display
11	USR1 User-defined Button	Press to launch a programmed command (for example, to turn a projector on)
12	USR2 User-defined Button	Press to launch a programmed command (for example, to turn a projector off)
13	MENU Button	Press to access/exit the OSD menu. Press and hold the MENU button to toggle between the same menu functions in CH1 and CH2 (for example, between CH1 brightness and CH2 brightness). When in the MIC Effects menu, press and hold the MENU button to toggle between MIC 1 and MIC 2

#	Feature	Function
14	◀ Button// VOLUME Button	Press to move to the previous level in the OSD screen. When not within the OSD menu, press to decrease the Audio CH1 volume
	▶ Button // VOLUME Button	Press to move to the next level in the OSD screen. When not within the OSD menu, increase the Audio CH 1 volume
	▽// VOLUME Button	Press to move down the menu list and to decrease numerical values. When in the transition mode and not within the OSD menu mode, press to decrease the Audio CH 2 volume
	△// VOLUME Button	Press to move up the menu list values and to increase numerical values. When in the transition mode and not within the OSD menu mode, press to increase the Audio CH 2 volume
	ENTER Button	Press to enter sub-menu items, and save. When in the transition mode and not within the OSD menu, performs as a TAKE button (to carry out a transition).
15	RESET to XGA/720P Button	Press to reset the video output resolution to XGA or 720p and change the deep color settings to Off on the output. Press and hold for about 3 secs to toggle between reset to XGA and reset to 720p
16	PANEL LOCK Button	Press and hold for about 3 seconds to lock/unlock the front panel buttons

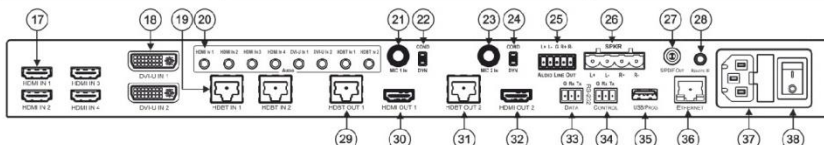

#	Feature	Function	
17	HDMI IN Connectors	Connect to the HDMI source (from 1 to 4)	
18	DVI-U IN Connectors	Connect to the video source that can be HDMI, VGA, Component or Composite video (from 1 to 2). See DVI-U pinout (Step 4)	
19	HDBT IN Connectors	Connect to an HDBT Transmitter (for example, the Kramer TP-580Txtr) to pass audio and video signals as well as serial commands (from 1 to 2)	
20	AUDIO Input Unbalanced Connectors	HDMI IN 3.5mm Mini Jack	Connect to an unbalanced audio source for HDMI 1 to HDMI 4 when using analog audio instead of embedded audio
		DVI-U IN 3.5mm Mini Jack	Connect to the unbalanced stereo audio of the DVI-U source (from 1 to 2)
		HDBT IN 3.5mm Mini Jack	Connect to the unbalanced stereo audio source for HDBT1 to HDBT 2 when using analog audio instead of embedded audio
21	MIC 1	6mm Jack	Connect to a microphone (see microphone pinout, Step 4)
		COND/DYN MIC Switch	Select between a condenser and a dynamic type microphone
22	MIC 2	6mm Jack	Connect to a microphone (see microphone pinout, Step 4).
		COND/DYN MIC Switch	Select between a condenser and a dynamic type microphone
25	AUDIO LINE OUT (L, R) Terminal Block	Connect to the L and R balanced stereo audio acceptor	
26	SPKR OUT 4-pin Terminal Block	Connects to a pair of loudspeakers	
27	S/PDIF OUT RCA Connector	Connect to a digital audio acceptor	
28	REMOTE IR 3.5mm Mini Jack (opening) Covered by a cap. The 3.5mm connector at the end of the internal IR connection cable fits through this opening	Connects to an external IR receiver unit for controlling the machine via an IR remote controller (instead of using the front panel IR receiver). Optional. Can be used instead of the front panel (built-in) IR receiver to remotely control the machine (only if the internal IR connection cable has been installed)	
29	Channel 1 output connectors	HDBT OUT 1 R.J-45	Connect to an HDBT receiver (for example, Kramer TP-580Rxtr) to pass Ethernet, audio and video signals, as well as serial commands
		HDMI OUT 1	Connect to an HDMI acceptor
31	Channel 2 Output Connectors	HDBT OUT 2 R.J-45	Connect to an HDBT receiver (for example, Kramer TP-580Rxtr) to pass Ethernet, audio and video signals, as well as serial commands
		HDMI OUT 2	Connect to an HDMI acceptor
33	RS-232 DATA Terminal Block Connectors	Connect to the PC or the remote controller and pass data between this RS-232 port and the serial matrix (see Step 8)	
34	RS-232 CONTROL Terminal Block Connectors	Connect to the PC or the remote controller for RS-232 control of the VP-778	
35	USB PROG Connector	Connects to a USB drive to upgrade the firmware	
36	ETHERNET Connector	Connects to the PC or other Controller through computer networking	
37	Power Connector with Fuse	AC connector, enabling power supply to the unit	
38	POWER Switch	Switch for turning the unit on or off	

Install the VP-778

To rack mount the machine attach both ear brackets to the machine (by removing the three screws from each side of the machine and replacing those screws through the ear brackets) or place the machine on a table.

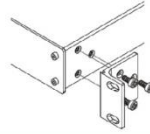

Connect the inputs and outputs

Always switch OFF the power on each device before connecting it to your VP-778. For best results, we recommend that you always use Kramer high-performance cables to connect AV equipment to the VP-778.

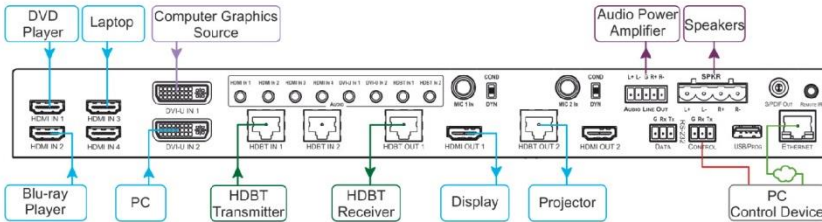

Note that you can connect DVI-U to an analog (VGA, composite or component video) or digital (HDMI or DVI) source.

RJ-45 Pinout:

For the Ethernet and HDBaseT connectors, see the proper wiring diagram below

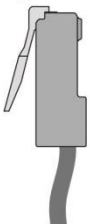

PIN EIA / TIA 568B	
PIN	Wire Color
1	Orange / White
2	Orange
3	Green / White
4	Blue
5	Blue / White
6	Green
7	Brown / White
8	Brown

Microphone pinout:



DVI-U Pinout:

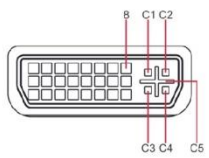

PIN	Wire Color
C1	Red / Pb
C2	Green / Y / CV
C3	Blue / Pr
C4	Horizontal sync (TTL)
C5	Common return
8	Vertical sync (TTL)

Connect the audio output:

To a balanced stereo audio acceptor

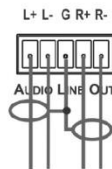

To an unbalanced stereo audio acceptor



Connect the power

Connect AC power to the rear of the VP-778, switch on its power and then switch on the power on each device.

Safety Instructions



- Caution:** There are no operator serviceable parts inside the unit.
 - Warning:** Use only the power cord that is supplied with the unit.
 - Warning:** Do not open the unit. High voltages can cause electrical shock! Servicing by qualified personnel only.
 - Warning:** Disconnect the power and unplug the unit from the wall before installing.
- See www.KramerAV.com for updated safety information.

Step 6: Set operation parameters via OSD menu

Enter the OSD menu via the MENU button on the front panel or the IR remote control transmitter. Select a menu item and set parameters as required.

If you cannot see any video output, verify that the display, TV, or projector is in good working order and is connected to the **VP-778**. Verify that the **VP-778** is selected as the source. If you still cannot see any video output, press and hold the **RESET TO XGA/720P** button for 3 seconds to reset the output to XGA or 720p resolution.

Menu Item	Function
Inputs	Sets the parameters for each input connector such as input type, native resolution, color depth, HDCP mode, audio input level and so on
Layout	Sets the display mode, transition settings (transition speed, mode, effects, direction, and take) and overlay settings (single window and PIP types), as well as output resolution and other output settings
Channel 1 / Channel 2	Sets the parameters for the Channel 1 / Channel 2 output including the source, aspect ratio, color settings, de-interlacing, noise reduction, projection, power save settings, test patterns, auto switching, audio settings and so on
Misc	Displays the information, OSD settings, USR keypad settings, FW upgrade and factory reset

Step 7: Operate via the front panel buttons and via the:

IR remote controller:



Web pages:

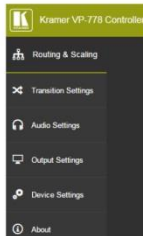

RS-232 and Ethernet:

RS-232			
Protocol 3000			
Baud Rate:	115,200	Stop Bits:	1
Data Bits:	8	Parity:	None
Example (decrease the volume on the DVI-U2 input): #Y 0,165,-<CR>			
TCP/IP Parameters			
IP Address:	192.168.1.39	UDP Port #:	50000
Subnet mask:	255.255.000.000	Maximum UDP Connections:	Unlimited
Default gateway:	192.168.0.1	Maximum TCP Connections:	Unlimited
TCP Port #:	5000		
Full Factory Reset			
OSD:	Factory Reset through the Misc menu item (including or excluding ETH)		
Protocol 3000:	Including ETH: use "Factory" command or #Y 0,561,1<CR>		
	Excluding ETH: use "Factory" command or #Y 0,562,1<CR>		
Web pages:	Factory reset via the Device Settings embedded Web page (including or excluding ETH)		
Front panel buttons:	Including ETH: power up the device with the "RESET TO XGA/720P" key pressed. The arrow and ENTER buttons flash. Full factory reset is complete once the LEDs cease to flash and react normally.		

Step 8: Pass serial data via the device:

The **VP-778** lets you route serial data through its various ports in the following ways:

- Serial matrix** – up to eight sets of unidirectional connections can be configured for passing serial data from a selected source to a selected destination.
 Select the source/destination ports: port tunneling, the DATA RS-232 port, HDBT IN1, HDBT IN2 HDBT OUT1 or HDBT OUT2.
- USR buttons** – a programmable command is launched to a selected destination with a press of a USR button.
 Select the destination ports: port tunneling, the DATA RS-232 port, HDBT IN1, HDBT IN2 HDBT OUT1, HDBT OUT2 or all.

Contents

1	Introduction	1
2	Getting Started	2
2.1	Achieving the Best Performance	2
2.2	Safety Instructions	2
2.3	Recycling Kramer Products	3
3	Overview	4
3.1	HDCP Compliance for HDMI inputs	7
3.2	About HDBaseT™ Technology	7
3.3	Using Twisted Pair Cable	7
3.4	Defining the VP-778 Presentation Matrix Switcher/Dual Scaler	7
4	Installing in a Rack	12
5	Connecting the VP-778	13
5.1	Wiring the RJ-45 Connectors	16
5.2	Connecting the Balanced Stereo Audio Line Output	17
5.3	Microphone Pinout	17
6	OSD Menu	18
6.1	OSD Menu Operation Example	18
6.2	Inputs Menu	21
6.3	Layout Menu	22
6.4	Channel 1 / Channel 2 Menus	24
6.5	Misc Menu	33
7	VP-778 Layout	37
7.1	Transition Mode	37
7.2	Overlay Mode	39
8	Controlling the VP-778	42
8.1	Controlling via the Front Panel Buttons	42
8.2	Connecting to the VP-778 via RS-232	48
8.3	Connecting the VP-778 via the ETHERNET Port	48
8.4	Controlling via the OSD Menu	52
8.5	Controlling via the Infrared Remote Control Transmitter	53
9	Using the Embedded Web Pages	55
9.1	Browsing the VP-778 Web Pages	55
9.2	Routing & Scaling the Image	57
9.3	Transition Settings Page	67
9.4	Audio Settings Page	69
9.5	Output Settings Page	73
9.6	Device Settings Page	74
9.7	About Page	78
10	Port Tunneling	79
11	Routing Serial Data	81
12	Flash Memory Upgrade	82
12.1	Firmware Upgrade Process	82
12.2	Rollback	84
13	Technical Specifications	86
13.1	Default Communication Parameters	87
13.2	Input Resolutions	88

13.3	Output Resolutions	89
14	VP-778 RS-232 Communication Protocol	90
14.1	Using the Communication Protocol	90
14.2	Communication Protocol: Mimicking OSD	90
14.3	Protocol Table: Mimicking Remote and Front Panel Buttons	101
14.4	Protocol 3000 Common Operation Commands	102
14.5	Understanding Protocol 3000	103
14.6	Kramer Protocol 3000 Syntax	105
14.7	Protocol 3000 Commands	106

Figures

Figure 1:	VP-778 Presentation Matrix Switcher/Dual Scaler Front Panel	8
Figure 2:	VP-778 Presentation Matrix Switcher/Dual Scaler Rear Panel	10
Figure 3:	Connecting the VP-778 Presentation Matrix Switcher/Dual Scaler	15
Figure 4:	TP PINOUT	16
Figure 5:	Connecting the Balanced Stereo Audio Output	17
Figure 6:	Connecting an Unbalanced Stereo Audio Acceptor to the Balanced Output	17
Figure 7:	Condenser Microphone Pinout	17
Figure 8:	Dynamic Microphone Pinout	17
Figure 9:	Inputs Menu	21
Figure 10:	Layout Menu	22
Figure 11:	Channel 1/Channel 2 Menus	24
Figure 12:	Talkover Mode	28
Figure 13:	Changing the Size of the Window	30
Figure 14:	Increasing the Width	30
Figure 15:	Increasing the Height	31
Figure 16:	Positioning the Window	31
Figure 17:	Window Customization	32
Figure 18:	H-Position Slide Bar	32
Figure 19:	Moving the PiP Window	33
Figure 20:	Misc Menu	33
Figure 21:	VGA superimposed over HDMI	41
Figure 22:	RS-232 Connection	48
Figure 23:	Local Area Connection Properties Window	49
Figure 24:	Internet Protocol Version 4 Properties Window	50
Figure 25:	Internet Protocol Version 6 Properties Window	51
Figure 26:	Internet Protocol Properties Window	52
Figure 27:	Infrared Remote Control Transmitter	53
Figure 28:	Routing and Scaling Page with Navigation List on Left	56
Figure 29:	Routing and Scaling Page	58
Figure 30:	Routing & Scaling Page – Auto Switching Window	60
Figure 31:	Routing & Scaling Page – Scan Mode	61
Figure 32:	Routing & Scaling Page – Setting Priorities	62
Figure 33:	Routing and Scaling Page – PROGRAM – ZOOM Window	63
Figure 34:	Routing and Scaling Page – Transition Take	64
Figure 35:	Routing and Scaling Page – Changing the Image Size	65
Figure 36:	Routing and Scaling Page – Selecting the Layout	65
Figure 37:	Routing and Scaling Page – Setting the Layout	66
Figure 38:	Routing and Scaling Page – Customized Dual Layout	66
Figure 39:	Transition Settings Page	67
Figure 40:	Audio Settings Page	69
Figure 41:	Mic Settings Page	70

Figure 42: Output Settings Page	73
Figure 43: Device Settings Page	74
Figure 44: Device Settings Page – Communication Warning	75
Figure 45: Device Settings Page – DHCP Window	75
Figure 46: Device Settings Page – DHCP ON Notification	76
Figure 47: Device Settings Page – Info Window	76
Figure 48: Device Settings Page – HDBT Info Window	77
Figure 49: Device Settings Page – Communication Warning	77
Figure 50: Device Settings Page – Factory Reset Message	78
Figure 51: About Page	78
Figure 52: Port Tunneling	79
Figure 53: Firmware Upgrade – list of Files to Upgrade	83
Figure 54: Firmware Upgrade – Upgrade Process	83
Figure 55: Firmware Upgrade – Upgrade Complete	84
Figure 56: Firmware Upgrade – list of Files to Rollback	84

1 Introduction

Welcome to Kramer Electronics! Since 1981, Kramer Electronics has been providing a world of unique, creative, and affordable solutions to the vast range of problems that confront video, audio, presentation, and broadcasting professionals on a daily basis. In recent years, we have redesigned and upgraded most of our line, making the best even better!

Our 1,000-plus different models now appear in 14 groups that are clearly defined by function: GROUP 1: Distribution Amplifiers; GROUP 2: Switchers and Routers; GROUP 3: Control Systems; GROUP 4: Format/Standards Converters; GROUP 5: Range Extenders and Repeaters; GROUP 6: Specialty AV Products; GROUP 7: Scan Converters and Scalers; GROUP 8: Cables and Connectors; GROUP 9: Room Connectivity; GROUP 10: Accessories and Rack Adapters; GROUP 11: Sierra Video Products; GROUP 12: Digital Signage; GROUP 13: Audio; and GROUP 14: Collaboration.

Congratulations on purchasing your Kramer **VP-778** Presentation Matrix Switcher/Dual Scaler. This product, which incorporates HDMI™ technology, is ideal for any application where switching and/or scaling of multiple video signals is required for projection purposes, e.g., conference rooms, boardrooms, auditoriums, hotels, churches, production studios, and rental & staging.

2 Getting Started

We recommend that you:

- Unpack the equipment carefully and save the original box and packaging materials for possible future shipment
- Review the contents of this user manual



Go to www.kramerav.com/downloads/VP-778 to check for up-to-date user manuals, application programs, and to check if firmware upgrades are available (where appropriate).

2.1 Achieving the Best Performance

To achieve the best performance:

- Use only good quality connection cables (we recommend Kramer high-performance, high-resolution cables) to avoid interference, deterioration in signal quality due to poor matching, and elevated noise levels (often associated with low quality cables)
- Do not secure the cables in tight bundles or roll the slack into tight coils
- Avoid interference from neighboring electrical appliances that may adversely influence signal quality
- Position your **VP-778** away from moisture, excessive sunlight and dust



This equipment is to be used only inside a building. It may only be connected to other equipment that is installed inside a building.

2.2 Safety Instructions



Caution: There are no operator serviceable parts inside the unit

Warning: Use only the power cord that is supplied with the unit

Warning: Do not open the unit. High voltages can cause electrical shock! Servicing by qualified personnel only

Warning: Disconnect the power and unplug the unit from the wall before installing

2.3 Recycling Kramer Products

The Waste Electrical and Electronic Equipment (WEEE) Directive 2002/96/EC aims to reduce the amount of WEEE sent for disposal to landfill or incineration by requiring it to be collected and recycled. To comply with the WEEE Directive, Kramer Electronics has made arrangements with the European Advanced Recycling Network (EARN) and will cover any costs of treatment, recycling and recovery of waste Kramer Electronics branded equipment on arrival at the EARN facility. For details of Kramer's recycling arrangements in your particular country go to our recycling pages at www.kramerav.com/support/recycling.

3 Overview

VP-778 is an 8 Input ProScale™ Presentation Matrix Switcher/Dual Scaler with seamless video cuts and 4K30 UHD output support. **VP-778** can be configured as a single 4K output (4K@30 UHD (3840x2160)) or dual HD scaler with full PIP capabilities.

The unit has 4 HDMI inputs; 2 universal (HDMI, VGA, YPbPr or CV) inputs on DVI-U connectors; and 2 HDBaseT inputs. It scales the video, embeds the audio, and outputs the signal to two independent HDMI outputs – each with a parallel HDBaseT output. The unit has both analog and embedded audio inputs and outputs, and includes audio DSP features. Two microphone inputs are also incorporated, as well as digital, analog balanced stereo and amplified speaker outputs. The machine may be externally controlled via its built-in webpages, RS-232 and IR; as well as via its front-panel and user-friendly menu-driven OSD.

The **VP-778** Presentation Switcher / Scaler features:

- Pix Perfect™ Scaling Technology – Kramer’s extremely high performance, State-of-the-Art scaling technology with extensive high-quality pull-down and de-interlacing algorithms, and full up-and down-scaling of the video inputs
- K-IIT XL™ Picture-in-Picture Image Insertion Technology for ultra-stable picture-in-picture, picture-and-picture and split screen capability
- Seamless video switching, transition type (swap or follow) and transition effect (cut or fade) via the OSD menu
- Dual scalers—for “live” seamless transitions from one source to another—with two independent outputs: a channel 2 output and a channel 1 output. The channel 2 output—including an OSD menu for making adjustments—can be used to determine how the scaled output will look before being displayed live during a presentation
- 8 CH2 input buttons for switching a selected input to the channel 2 output and 8 CH1 input buttons for switching a selected input to the channel 1 output
- Main and PIP window customization in the overlay mode
- Front, back, ceiling front and ceiling back projection setups

- Maximum output resolution – 4K30 UHD (3840x2160), in the Single Window mode, HDTV and computer graphics resolutions with selectable refresh rates
- Selectable HDMI, VGA, YUV or CV on two DVI-U inputs, four HDMI and two HDBT inputs
- Two programmable user buttons that can launch a programmed command (for example, to turn a projector on/off) to a selected destination (DATA RS-232 port, HDBT IN1, HDBT IN2 HDBT OUT1, HDBT OUT2 or all) with a press of a button
- Serial matrix – Up to eight sets of unidirectional connections can be configured for passing serial data from a selected source to a selected destination (port tunnelling, the DATA RS-232 port, HDBT IN1, HDBT IN2 HDBT OUT1 or HDBT OUT2)
- HDBaseT™ technology with a maximum data rate of up to 6.75Gbps (2.25Gbps per graphic channel)
- System range (HDBaseT) – Up to 130m (430ft) normal mode; up to 180m (590ft) in ultra-mode (1080p @60Hz @24bpp) when using Kramer cables.



For optimum range and performance use the recommended Kramer cables available at www.kramerav.com/product/VP-778.

- Balanced stereo audio inputs, with two unbalanced microphone inputs, as well as digital stereo and balanced stereo outputs
- A built-in 2x10W power amplifier with speaker outputs on a 4-pin terminal block connector
- Selectable microphone talkover or mix modes
- Auto switching, automatically scans the inputs (based on a predefined priority) and selects the first live one found or the last connected
- Audio-Follow-Video (AFV) and breakaway options
- Advanced deinterlacing functions, including 3D comb filtering, film mode, diagonal correction and motion detection
- Multiple aspect ratio selections
- Built-in proc-amp with enhanced functions such as color correction, gamma, dither and noise reduction

- Embedded/de-embedded HDMI and HDBT audio support as well as eight balanced stereo audio inputs and two balanced stereo outputs
- Input and output audio level adjustment and audio DSP functions
- Selectable power management modes for energy efficient usage
- HDCP compliance

In addition, the **VP-778**:

- Features luma- and chroma-keying
- Features advanced EDID management (native resolution and color depth mode line) per input
- Lets you perfectly shift the ratio to get the best image positioning possible
- Includes built-in test patterns for screen setup and alignment
- Analyses the connected output's EDID for optimal scaling
- Provides input and output color space control
- Supports HDMI deep color for outputs
- Comes with an On-Screen Display (OSD) for easy setup and adjustment
- Has a non-volatile memory that retains the settings
- Supports firmware upgrade via USB (via memory stick)

Control your **VP-778**:

- Directly, via the front panel push buttons
- Via the Ethernet via webpage
- Remotely, from the infrared remote control transmitter
- By RS-232 serial commands transmitted by a touch screen system, PC, or other serial controller

The **VP-778** is housed in a 19" 1U rack mountable enclosure, with handles and rack ears included, and is fed from a 100-240 VAC universal switching power supply.

3.1 HDCP Compliance for HDMI inputs



If an HDMI signal is HDCP protected, it can only appear on HDMI outputs that are connected to HDCP compliant displays.

The **VP-778** will not output a picture on an HDMI display that is not HDCP compliant; instead it will show a green screen.

In the PiP mode (see [Section 7.2](#)), even if only one of the inputs is HDCP protected, and is output to a non-compliant display, it will affect the entire screen and turn it green.

3.2 About HDBaseT™ Technology

HDBaseT™ is an advanced all-in-one connectivity technology (supported by the HDBaseT Alliance). It is particularly suitable in the ProAV – and also the home – environment as a digital networking alternative, where it enables you to replace numerous cables and connectors by a single LAN cable used to transmit, for example, uncompressed full high-definition video, audio, IR, as well as various control signals.



The products described in this user manual are HDBaseT certified.

3.3 Using Twisted Pair Cable

Kramer engineers have developed special twisted pair cables to best match our digital twisted pair products. For optimum range and performance use the recommended Kramer cables available at www.kramerav.com/product/VP-778.



We strongly recommend that you use shielded twisted pair cable.

3.4 Defining the VP-778 Presentation Matrix Switcher/Dual Scaler

This section defines the **VP-778**.

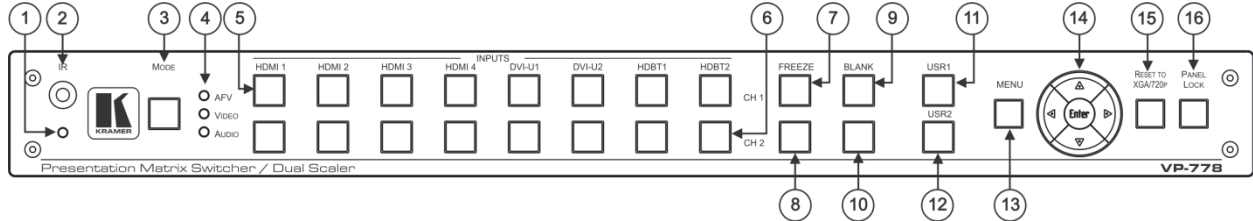

Figure 1: VP-778 Presentation Matrix Switcher/Dual Scaler Front Panel

#	Feature	Function	
1	IR LED	Lights red when the unit accepts IR remote commands	
2	IR Receiver	Accepts IR remote commands	
3	MODE Button	Select the operation mode: audio follow (AFV), Video or audio	
4	Mode LED indicators	Indicate the operation mode, as selected via the MODE button	
5	CH 1 INPUT Selector Buttons	HDMI	Press to select the HDMI input (from 1 to 4)
		DVI-U	Press to select the DVI universal input: HDMI, VGA, component or composite video (from 1 to 2)
		HDBT	Press to select the HDBT input (from 1 to 2)
6	CH 2 INPUT Selector Buttons	HDMI	Press to select the HDMI input (from 1 to 4)
		DVI-U	Press to select the DVI universal input: HDMI, VGA, component or composite video (from 1 to 2)
		HDBT	Press to select the HDBT input (from 1 to 2)
7	CH 1 FREEZE Button	Press to freeze/unfreeze the CH 1 output video image	
8	CH 2 FREEZE Button	Press to freeze/unfreeze the CH 2 output video image	
9	CH 1 BLANK Button	Press to toggle between a blank screen (black) and the CH 1 display	
10	CH 2 BLANK Button	Press to toggle between a blank screen (black) and the CH 2 display	
11	USR1 User-defined Button	Press to launch a programmed command (for example, to turn a projector on), see Section 8.1.4	
12	USR2 User-defined Button	Press to launch a programmed command (for example, to turn a projector off), see Section 8.1.4	
13	MENU Button	Press to access/exit the OSD menu, see Section 6 Press and hold the MENU button to toggle between the same menu functions in CH1 and CH2 (for example, between CH1 Brightness and CH2 brightness). When in the MIC Effects menu, press and hold the MENU button to toggle between MIC 1 and MIC 2.	

#	Feature	Function	
14	Navigation Buttons	◀ Button// VOLUME Button	Press to move to the previous level in the OSD screen (see Section 6). When not within the OSD menu, press to decrease the Audio CH1 volume
		▶ Button // VOLUME Button	Press to move to the next level in the OSD screen (see Section 6). When not within the OSD menu, increase the Audio CH 1 volume
		▽// VOLUME Button	Press to move down the menu list (see Section 6) and to decrease numerical values. When in the transition mode and not within the OSD menu mode, press to decrease the Audio CH 2 volume
		△// VOLUME Button	Press to move up the menu list values (see Section 6) and to increase numerical values. When in the transition mode and not within the OSD menu mode, press to increase the Audio CH 2 volume
		ENTER Button	Press to enter sub-menu items, and save (see Section 6). When in the transition mode and not within the OSD menu, performs as the TAKE button (to carry out a transition).
15	RESET TO XGA/720P Button	Press to reset the video output resolution to XGA or 720p and change the deep color settings to Off on the output. Press and hold for about 3 seconds to toggle between reset to XGA and reset to 720p	
16	PANEL LOCK Button	Press and hold for about 3 seconds to lock/unlock the front panel buttons	

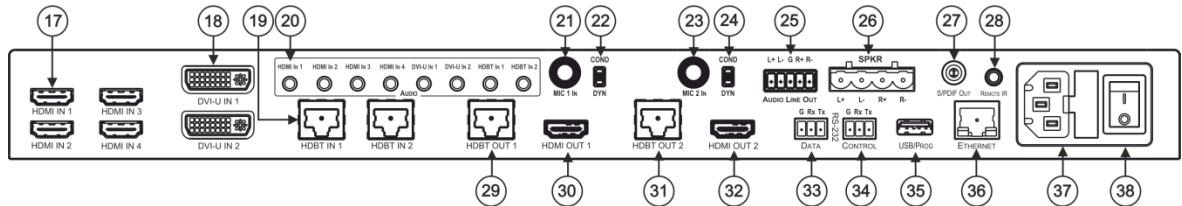

Figure 2: VP-778 Presentation Matrix Switcher/Dual Scaler Rear Panel

#	Feature	Function	
17	HDMI IN Connectors	Connect to the HDMI source (from 1 to 4)	
18	DVI-U IN Connectors	Connect to the video source that can be HDMI, VGA, Component or Composite video (from 1 to 2)	
19	HDBT IN Connectors	Connect to an HDBT Transmitter (for example, the Kramer TP-580Txr) to pass audio and video signals as well as serial commands (from 1 to 2)	
20	AUDIO Input Unbalanced Connectors	HDMI IN 3.5mm Mini Jack	Connect to an unbalanced audio source for audio takeover of the HDMI 1 to HDMI 4 embedded audio
		DVI-U IN 3.5mm Mini Jack	Connect to the unbalanced stereo audio of the DVI-U source (from 1 to 2)
		HDBT IN 3.5mm Mini Jack	Connect to the unbalanced stereo audio source for audio takeover of the HDBT1 to HDBT 2 embedded audio)
21	MIC 1	6mm Jack	Connect to a microphone (see pinout in Section 5.3)
		COND/DYN MIC Switch	Select between a condenser and a dynamic type microphone
23	MIC 2	6mm Jack	Connect to a microphone (see pinout in Section 5.3) Note that Mic2 on the rear panel is identical to Mic2 on the front panel. Mic2 on the front panel overrides Mic2 on the rear panel when connected
		COND/DYN MIC Switch	Select between a condenser and a dynamic type microphone
25	AUDIO LINE OUT (L, R) Terminal Block Connector	Connect to the L and R balanced stereo audio acceptor	
26	SPKR OUT 4-pin Terminal Block	Connects to a pair of loudspeakers	
27	S/PDIF OUT RCA Connector	Connect to a digital audio acceptor	
28	REMOTE IR 3.5mm Mini Jack (opening)	Connects to an external IR receiver unit for controlling the machine via an IR remote controller (instead of using the front panel IR receiver)	
	Covered by a cap. The 3.5mm connector at the end of the internal IR connection cable fits through this opening	Optional. Can be used instead of the front panel (built-in) IR receiver to remotely control the machine (only if the internal IR connection cable has been installed)	

#	Feature		Function
29	Channel 1 output connectors	HDBT OUT 1 RJ-45	Connect to an HDBT receiver (for example, Kramer TP-580Rxr) to pass Ethernet, audio and video signals, as well as serial commands
30		HDMI OUT 1	Connect to an HDMI acceptor
31	Channel 2 Output Connectors	HDBT OUT 2 RJ-45	Connect to an HDBT receiver (for example, Kramer TP-580Rxr) to pass Ethernet, audio and video signals, as well as serial commands
32		HDMI OUT 2	Connect to an HDMI acceptor
33	RS-232 DATA Terminal Block Connectors		Connect to the PC or the remote controller and pass data between this RS-232 port and the HDBT OUT port or one of the HDBT IN ports
34	RS-232 CONTROL Terminal Block Connectors		Connect to the PC or the remote controller
35	USB PROG Connector		Connects to a USB drive to upgrade the firmware
36	ETHERNET Connector		Connects to the PC or other Controller through computer networking
37	Power Connector with Fuse		AC connector, enabling power supply to the unit
38	POWER Switch		Switch for turning the unit on or off

4 Installing in a Rack

This section provides instructions for rack mounting the unit.

Before installing in a rack, be sure that the environment is within the recommended range:

OPERATING TEMPERATURE:	0° to +40°C (32° to 104°F)
STORAGE TEMPERATURE:	-40° to +70°C (-40° to 158°F)
HUMIDITY:	10% to 90%, RHL non-condensing



CAUTION!

When installing on a 19" rack, avoid hazards by taking care that:

1. It is located within the recommended environmental conditions, as the operating ambient temperature of a closed or multi unit rack assembly may exceed the room ambient temperature.
2. Once rack mounted, enough air will still flow around the machine.
3. The machine is placed straight in the correct horizontal position.
4. You do not overload the circuit(s). When connecting the machine to the supply circuit, overloading the circuits might have a detrimental effect on overcurrent protection and supply wiring. Refer to the appropriate nameplate ratings for information. For example, for fuse replacement, see the value printed on the product label.
5. The machine is earthed (grounded) in a reliable way and is connected only to an electricity socket with grounding. Pay particular attention to situations where electricity is supplied indirectly (when the power cord is not plugged directly into the socket in the wall), for example, when using an extension cable or a power strip, and that you use only the power cord that is supplied with the machine.

To rack-mount a machine:

1. Attach both ear brackets to the machine. To do so, remove the screws from each side of the machine (3 on each side), and replace those screws through the ear brackets.

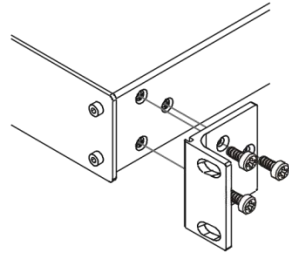

2. Place the ears of the machine against the rack rails, and insert the proper screws (not provided) through each of the four holes in the rack ears.

Note:

- In some models, the front panel may feature built-in rack ears
- Detachable rack ears can be removed for desktop use
- Always mount the machine in the rack before you attach any cables or connect the machine to the power
- If you are using a Kramer rack adapter kit (for a machine that is not 19"), see the Rack Adapters user manual for installation instructions available from our Web site

5 Connecting the VP-778



Always switch off the power to each device before connecting it to your **VP-778**. After connecting your **VP-778**, connect its power and then switch on the power to each device.



You do not have to connect all the inputs and outputs, connect only those that are required.

To connect the VP-778, as illustrated in the example in [Figure 3](#):

1. Connect an HDMI source (for example, a Blu-ray player) to the HDMI IN 1 connector.

Alternatively, you can connect the DVI connector on the DVD player to the HDMI connector on the **VP-778** via a DVI-HDMI adaptor. You can connect the audio signal via the AUDIO IN HDMI 3.5mm mini jack, or use the embedded audio

2. Connect a digital or analog source (for example, a Laptop) to the DVI-U universal connector (from 1 to 2).

You can connect an analog (VGA, composite or component video) or digital (HDMI or DVI) source to the universal DVI connector

3. Connect an HDBT transmitter (for example, **TP-580Txr**) to the RJ-45 HDBT IN connectors (from 1 to 2).
4. Connect the audio inputs (not shown in [Figure 3](#)) to the:
 - HDMI IN audio input 3.5mm mini jacks (from 1 to 4)
 - DVI-U IN audio input 3.5mm mini jacks (from 1 to 2)
 - HDBT IN audio input 3.5mm mini jacks (from 1 to 2)
5. Connect the HDMI OUT 1 to an HDMI acceptor (for example, a projector).
6. Connect the HDBT OUT 1 RJ-45 connector to an HDBT receiver (for example, the input of **TP-580Rxr** connected to HDBT)

7. Connect the HDMI OUT 2 to an HDMI acceptor (for example, an LCD display).
8. Connect the HDBT OUT 2 RJ-45 connector to an HDBT receiver (for example, the input of **TP-580Rxr** connected to HDBT).
9. Connect the AUDIO LINE OUT Terminal Block connector to a balanced audio acceptor and the S/PDIF OUT RCA connector to a digital audio acceptor (not shown in [Figure 3](#)).
10. Connect the SPKR OUT block connector to a pair of loudspeakers, by connecting the left loudspeaker to the “L+” and the “L-” terminal block connectors, and the right loudspeaker to the “R+” and the “R-” terminal block connectors. **Do not Ground the loudspeakers.**
11. If required, you can connect a PC and/or controller to the:
 - RS-232 CONTROL terminal block connectors (see [Section 8.2](#))
 - RS-232 DATA terminal block connectors for sending RS-232 commands via HDBT (see [Section 8.2](#))
 - Ethernet connector (see [Section 8.3](#))
12. Connect the power cord (not shown in [Figure 3](#)).

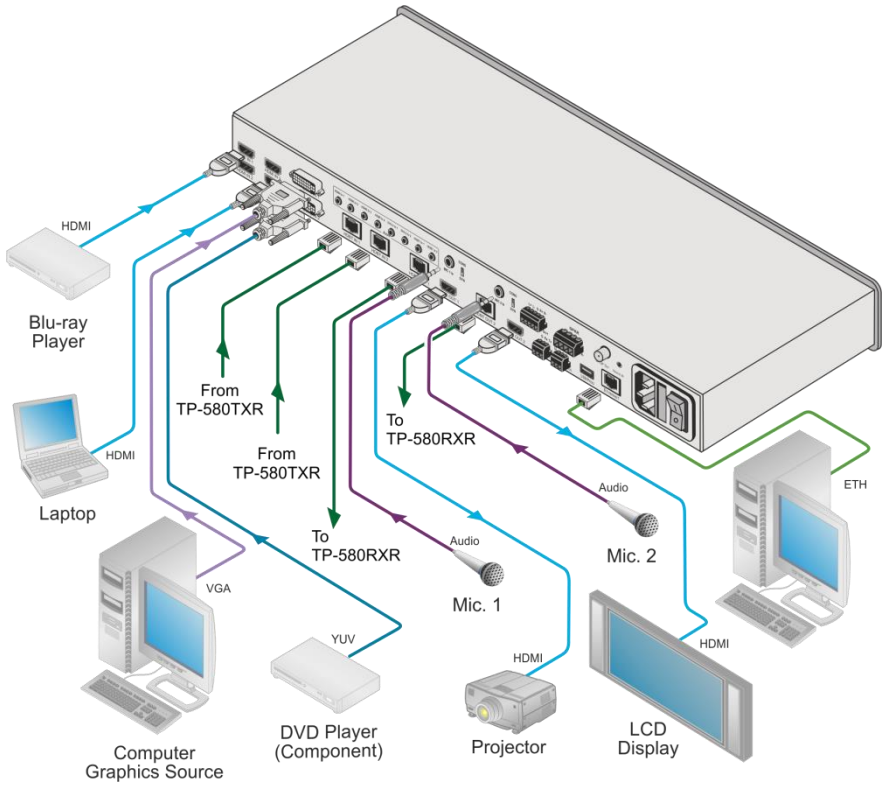

Figure 3: Connecting the VP-778 Presentation Matrix Switcher/Dual Scaler

5.1 Wiring the RJ-45 Connectors

This section defines the TP pinout, using a **straight** pin-to-pin cable with RJ-45 connectors.

EIA / TIA 568B	
PIN	Wire Color
1	Orange / White
2	Orange
3	Green / White
4	Blue
5	Blue / White
6	Green
7	Brown / White
8	Brown

Figure 4: TP PINOUT

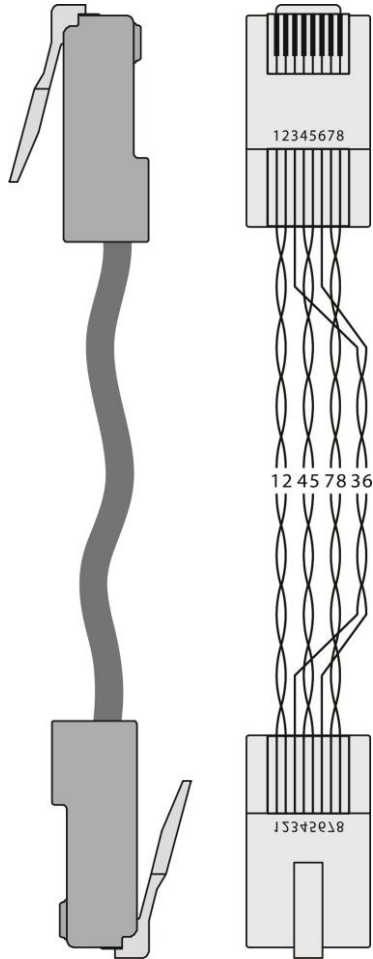

5.2 Connecting the Balanced Stereo Audio Line Output

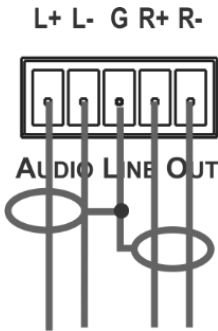

Figure 5: Connecting the Balanced Stereo Audio Output

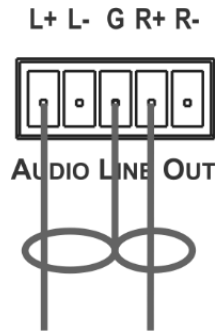

Figure 6: Connecting an Unbalanced Stereo Audio Acceptor to the Balanced Output

5.3 Microphone Pinout

This section defines the microphone pinout.

The microphone 6mm jack pinout for a condenser microphone.

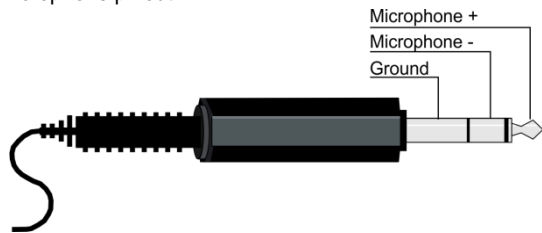

Figure 7: Condenser Microphone Pinout

The microphone 6mm jack pinout for a dynamic microphone.

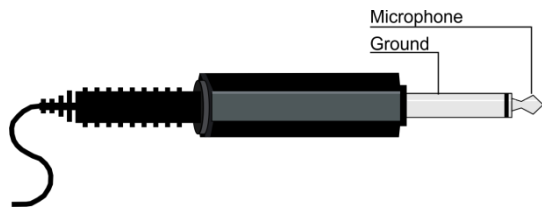

Figure 8: Dynamic Microphone Pinout

6 OSD Menu

The OSD menu lets you set the **VP-778** operation parameters.



Note that the OSD appears only on the CH 2 output in the Overlay mode.

The OSD sub-menu operations appear in the OSD title, as shown in the example in [Section 6.1](#):

- When in the main menu, the OSD title appears empty
- Level 1 lists the main menu items
- Level 2 includes the second hierarchy level, below level 1
- Level 3 includes the third hierarchy level, below level 2 (optional)
- Level 4 includes the fourth hierarchy level, below level 3 (optional)
- Levels 5 and higher are used in some of the menus in the same way
- Function (the last level), is the selectable parameter or numerical value and can appear either under level 2, 3, 4, 5, 6 or 7

6.1 OSD Menu Operation Example

In the example described below, the Master Connection is set to HDMI2.

The table below shows function 242 (from the Protocol in [Section 14.2](#)):

- 2 in the hundreds, represents “Layout” which is the 2nd menu item in the main menu list
- 4 in the tens, represents “Output” which is 4th in the Scale menu
- 2 in the units, represents “Master Connection” which is second in the Output menu

Level 1	Level 2	Level 3	Level 4 (Function)	Range	Function
Scale (2)	Output (4)	Master Connection (2)	HDMI1	0	242
			HDBT1	1	
			HDMI2	2	
			HDBT2	3	

The subtitle, below the title line shows the current level accessed (Scale in this example)

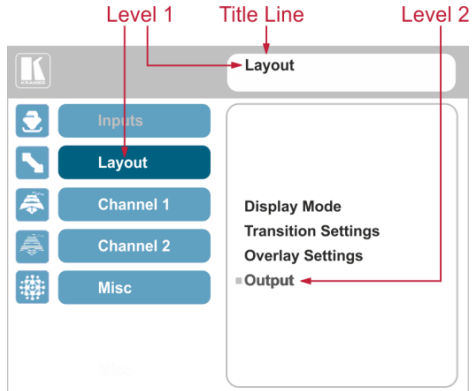

After selecting Output (which is the second Level), it appears in the subtitle

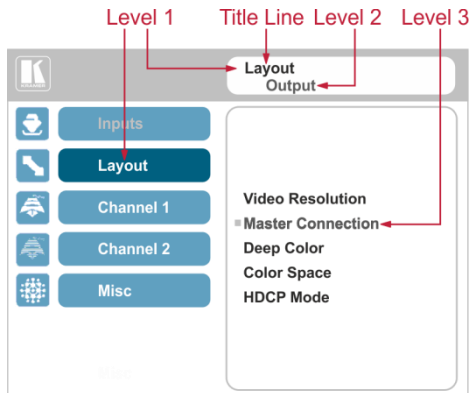

The subtitle shows the current, Level 3, selection and the menu list shows the function (HDMI2)

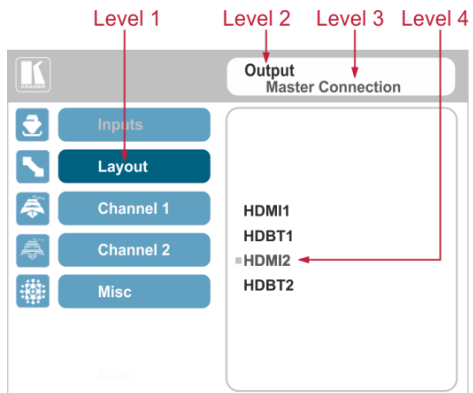

Note that:

- A selected parameter that turns gray becomes valid immediately. You can press Enter at this point to save these parameter changes to the memory immediately (the screen will display “Saving Data” for a split second).
- Functions may also have 2 digits only (Display Mode, for example is 21)
- Parameters that appear red are not available
- In any case, exiting the menu saves the parameter to the memory
- Data is saved per window and per input (to a dedicated input + window memory), as applicable

The control buttons let you control the **VP-778** via the OSD menu. Press the:

- MENU (or <|) button to enter the menu, exit the menu, and when in the OSD menu, move to the previous level and change menu settings in the OSD screen.

Changes are immediate

The default timeout is set to 30 seconds and can be changed (see [Section 6.5](#))

- ENTER (or ▷) button to access sub-menu items
- Arrow buttons to move through the OSD menu
- Up or down arrows to change settings



When exiting the menu, all the changes are automatically saved to the non-volatile memory.

The default OSD timeout for auto exit is set to 30 seconds and can be changed (see [Section 6.5](#)).

6.2 Inputs Menu

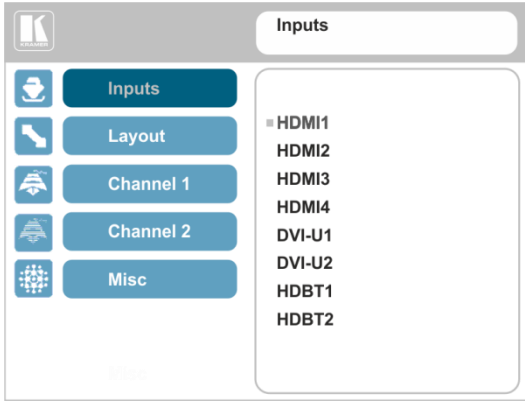



Figure 9: Inputs Menu

Setting	Function
	Set the parameters for each of the inputs: HDMI1, HDMI2, HDMI3, HDMI4, DVI-U1, DVI-U2, HDBT1, HDBT2
	Note that if you are setting the parameters of a selected input (front button panel illuminates) an "Active Input" warning appears
Type	Select the signal type for the DVI-U inputs: HDMI , YUV , VGA , or CV  Note that YUV, VGA or CV signals are only valid for when a DVI input is connected.
EDID Management	Set the: Native Resolution – select the native resolution for each input (for HDMI, HDBT and VGA inputs only): 1024x768@60, 1280x800@60, 1280x1024@60, 1366x768@60, 1440x900@60, 1400x1050@60, 1600x900@60, 1600x1200@60, 1680x1050@60, 1920x1200@60RB, 720p50, 720p60, 1080p50, 1080p60, 2k50 or 2k60 Color Depth – select the color depth to be 12bpp or 8bpp after selecting the native resolution. Modeline – Native as Multiple Modelines – generating a group of resolutions in the detailed timing, including the native resolution), or Native as Single Modeline – generating only the native resolution in the detailed timing Audio Channels – Select 5.1 or Stereo
HDCP Mode	Select the HDCP option for each HDMI/HDBT input: either On (the default) or Off Setting HDCP mode to Off on the HDMI/HDBT input allows the source to transmit a non-HDCP signal if required (for example, when working with a Mac computer). Note that if you did not get the source to transmit the desired result, make sure you have saved the change (by pressing the ENTER button) and then physically disconnect and reconnect the cable connecting the source to the HDMI/HDBT input
Color Space	Select the color space for each input to RGB , YPbPr or Follow Input
Volume	Slide the progress bar to set the audio level for each input

6.3 Layout Menu

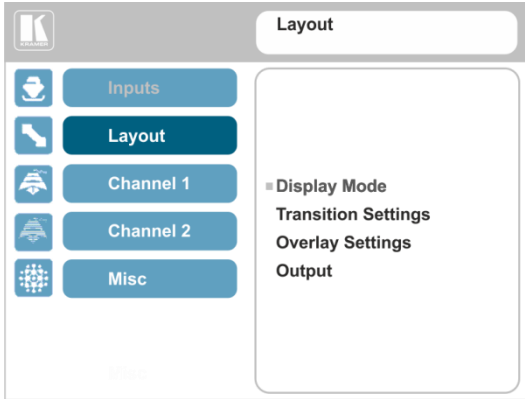



Figure 10: Layout Menu

Setting	Function	
Display Mode	Set to the Transition mode or the Overlay mode (see Section 7)	
Transition Settings	Speed	Slide the progress bar to set the transition speed
	Mode	Set the transition mode to either Swap (Channel 1 and Channel 2 sources switch places) or Follow (the Channel 1 source follows the Channel 2 source)
	Effect	Select one of the following effects: Cut or Fade
	Direction	N/A
	Take	Select to carry out the transition
Overlay Settings	Single Window	Set to a single window mode operation with one channel displayed
	Picture in Picture	(PiP) – dual window mode operation, a smaller window superimposed over a full screen image (see Section 7.2)
	Picture + Picture	(PoP) – dual window mode operation, both images appear side-by-side and the aspect ratios of both images are maintained (see Section 7.2)
	Split	(SbS) – dual window mode operation, both images are placed side-by-side with the same height (see Section 7.2)
	Customized Single	Select the customized Channel 1 window as set in Window Customization, see Section 6.4
	Customized Dual	Select the customized Channel 2 window as set in Window Customization, see Section 6.4
Output	Video Resolution	Select the output resolution: Native, 640x480@60, 640x480@75, 800x600@50, 800x600@60, 800x600@75, 1024x768@50, 1024x768@60, 1024x768@75, 1280x768@50, 1280x768@60, 1280x800@60, 1280x1024@50, 1280x1024@60, 1280x1024@75, 1360x768@60, 1366x768@50, 1366x768@60, 1400x1050@50, 1400x1050@60, 1600x900@60, 1600x1200@50, 1600x1200@60, 1680x1050@60, 1920x1200@60RB, 480p60, 576p50, 720p50, 720p59.94, 720p60, 1080i50, 1080i60, 1080p23.976, 1080p24, 1080p25, 1080p29.97, 1080p30, 1080p50, 1080p59.94, 1080p60, 2k50, 2k60, 4k2k30
		 Note that setting the output resolution to 4k2k30 will automatically change the window settings to Single Window in the Overlay mode.

Setting	Function
Master Connection	Set HDMI1, HDBT1, HDM2 or HDBT2 to be the Master connection (see Section 6.3.1). If the native resolution is not supported by the selected Master Connection, the system searches for the best supported resolution. If the search fails (for example, if the master connection is disconnected or EDID is unreadable), the resolution will default to XGA.
Deep Color	Set to Off or Follow Output
Color Space	Select RGB, YPbPr422 or YPbPr444
HDCP Mode	Define the output HDCP activation policy. Set to: Follow Output (this option is recommended when the HDMI type output is connected to a splitter/switcher) – to activate the HDCP per output according to the setting of the HDMI acceptor to which it is connected; that is, if the HDMI acceptor is not HDCP compliant, the VP-778 always outputs without HDCP and vice versa. Follow Input – to activate the HDCP on all HDMI type outputs in the case that the video on the Main or PiP window is HDCP encrypted. Note that the VP-778 will output a green screen if the output acceptor to which it is connected is not HDCP compliant, in the case that the video on the Main or PiP window is HDCP encrypted.

6.3.1 Master Connection Settings

The Master Connection (HDMI OUT1, HDBT OUT1, HDMI OUT2 or HDBT OUT2) is usually set to the main output display so that the optimal resolution for that display can be obtained.

By setting the output resolution to Native, the **VP-778** is triggered to read the EDID of the main display and change the output resolution value according to the native resolution of the display.

If HDMI/HDBT is selected as the Master Connection, and a new display is connected to the Master Connection output (hot plug), the **VP-778** automatically reads the EDID of that display and updates the output resolution accordingly.

If it is not supported by the selected Master Connection, the system searches for the best supported resolution. If the search fails (for example, if the master connection is disconnected or EDID is unreadable), the resolution will default to XGA.

6.4 Channel 1 / Channel 2 Menus

The Channel 1 and Channel 2 menus are identical.

Note that when browsing the Channel 1 OSD menu, use a long press on the MENU button to jump to the same menu item in the Channel 2 menu and vice versa.

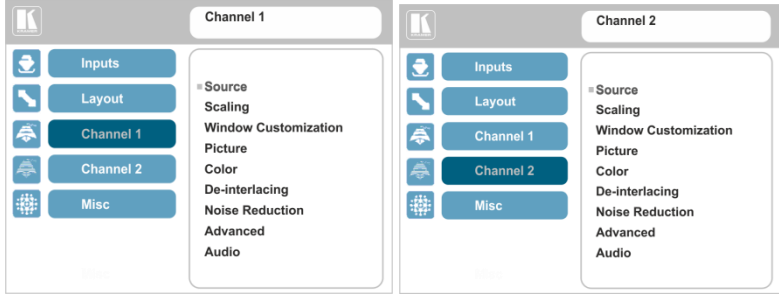
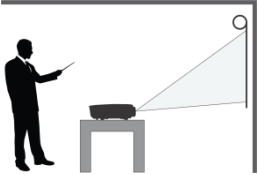
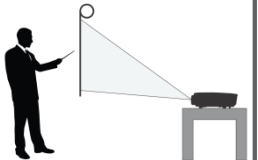
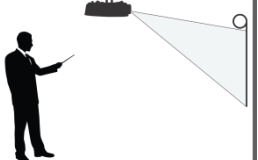
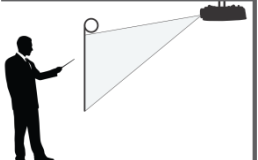



Figure 11: Channel 1/Channel 2 Menus

Setting	Function	
Source	Select the source: HDMI 1, HDMI 2, HDMI 3, HDMI 4, DVI-U1, DVI-U2, HDBT 1 or HDBT 2 and then set the parameters below (which are specific per input)	
Scaling	Aspect Ratio	Set (see Section 6.4.2) to: Follow Input – If the input resolution ≤ output resolution, display with a blank border. input > output is denied and the aspect ratio automatically changes to Follow Output Follow Output – If the input resolution < output resolution, scale up the picture. If the input resolution > output resolution, scale down the picture Best Fit – the best possible compromise between the input and the output aspect ratios Channel 1 Letterbox – to compress the top and bottom edges of the input signal, but fill the width of the screen Note that when in the overlay mode (any setting other than Single Window), the aspect ratio will be set to Follow Output. Any other setting will set the overlay mode to Single Window
	Overscan	Set the Overscan to Follow Input, Off, 5% or 10%
	Zoom Shift Mode	Auto – to set zoom to 100% and fit the image to the display Semi Auto – to manually set the zoom and shift. Changes until the resolution is changed and/or the source is replaced Customized – to manually set the zoom shift (H image shift and V Image Shift)
	Zoom	Slide the progress bar to set the zoom. If Zoom Shift Mode is set to Auto, this function is disabled
	H image Shift	Slide the progress bar to set the horizontal position of the image within the window (note that this is a volatile parameter when selecting Zoom Shift Mode > Auto)
V image Shift	Slide the progress bar to set the vertical position of the image within the window (note that this is a volatile parameter when selecting Zoom Shift Mode > Auto)	
Window Customization	Slide the progress bar to set the H position and Width , V position and Width which will appear when selecting Customized Single/Dual in Layout-Overlay Settings, see Section 6.3	

Setting	Function	
Picture	Brightness	Slide the progress bar to set the brightness level
	Contrast	Slide the progress bar to set the contrast level
	H Sharpness	Slide the progress bar to select the horizontal sharpness level
	V Sharpness	Slide the progress bar to select the vertical sharpness level
Color	Chroma	Slide the progress bar to set the color level
	Hue	Slide the progress bar to set the color hue
	Color Temperature	Set the color temperature to 6500K or 9300K
	Gamma Mode	Set the gamma correction factor to Off, 0.4, 0.8, 1.2, 1.6, 2.0, 2.4 or 2.8 The higher the value, the darker the image
	Color Correction Blue	Slide the progress bar to set the blue color level from 0 to 4
	Color Correction Green	Slide the progress bar to set the green color level from 0 to 4
	Color Correction Flesh	Slide the progress bar to set the flesh color level from 0 to 4
	De-interlacing	Film Mode
PD Time		Slide the progress bar to set the pull down time (0 to 15)
Motion Detection Sensitivity		Set (from Level 1 to Level 5) Select the motion detection sensitivity for filtering of interlaced images. Set a high value for video where there is generally a large amount of motion, or a low value for little motion
Diagonal Correction		Slide the progress bar to set the level of diagonal interpolation from 0 to 3. When set to the lower level, the diagonal image does not appear smooth
Noise Reduction	Horizontal NR	Slide the progress bar to reduce the horizontal noise
	Vertical NR	Slide the progress bar to reduce the vertical noise
	Temporal NR	Slide the progress bar to set the temporal NR The higher the level, the stronger the filtering of the image. Useful when the noise is visible to the eye
	Block NR	Slide the progress bar to set the Block NR As the level is set higher, the block noise disappears and the image appears softer
	Mosquito NR	Slide the progress bar to set the Mosquito NR The higher the level, the stronger the filtering of the image
	Combing NR	Slide the progress bar to set the Combing NR Improves the quality of the subtitles

Setting	Function	
Advanced	Projection	<p>Set to:</p> <p>Front – to place a projector in front of the screen</p>  <p>Back – to place a projector behind the screen</p>  <p>Ceiling Front – to suspend a projector from the ceiling upside-down in front of the screen</p>  <p>Ceiling Back – to suspend a projector from the ceiling upside-down behind the screen</p> 
	Pause	<p>Set the output Freeze, Blank and Mute to On or Off:</p> <p>Set Freeze to On to freeze the window (freezing the window will also mute the audio output)</p> <p><i>Any change in the input source may cancel the freeze and blank settings</i></p> <p>Set Blank to On to display a blank window (blanking the window will also mute the audio output)</p> <p><i>Any change in the input source may cancel the freeze and blank settings</i></p> <p>Set Mute to On to mute the audio output</p> <p>A mute icon appears on screen for a few seconds.</p>
	Sync Off	<p>Set to Auto to enter the power save mode after a set time (1 to 5 minutes) if no input is present.</p> <p>Set to Manual to enter the power save mode (once Manual is selected, a 5-second countdown appears, letting you cancel the process and revert to the previous state by pressing the MENU or left arrow button)</p> <p>This is useful, for example, when the output is connected to a projector, and the projector will automatically shut down when it has no input.</p> <p>Press any front panel button or key on the IR remote control transmitter to exit the Sync Off mode</p>

Setting	Function	
	Test Pattern	Set the Test pattern to Slide Bar (non-HDCP), Color Bar (HDCP) or Off . Each test pattern includes a sinusoid audio signal at 10dB @1kHz. We recommend that you set the Display Mode to Single Window and set the Output Resolution to 1080p.
	No Signal	If there is no signal on the input set the output color to Gray, Blue or Black
	Fade-Thru	When switching inputs, select fade thru Black or fade thru Freeze
	Auto Switching	Set the Mode and the Priority Mode – set to Off, Scan Mode or Last Connected In scan mode, as the device scans each of the active (connected) inputs, each of the corresponding input buttons briefly lights blue Priority – is effective in Scan Mode Only – set the switching priority for each input from 1 (the highest priority) to 8 (the lowest priority) and enable or disable each priority level (Active: on/off)
Audio	Source	Select the audio source to be: AFV for the audio to follow the video Analog 1 to Analog 8 to select any of the analog audio inputs
	AFV Source	When in the AFV mode, select Embedded for the embedded audio source to follow the video Select Analog for the analog audio source to follow the video Applies only when in the AFV mode
	Proc Amp	Slide the progress bar to set the Output Volume level and Bass level [dB] Slide the progress bar to adjust the Midrange frequency, the Treble and the Balance
	Lip Sync	Slide the progress bar to set the Lip Sync delay value [msec]
	Pass-Through	Set to pass-through to On to pass the input audio to the output or set to Off.
	Mic Effect	For Channel 1 only (see Section 6.4.1)
		Note that the audio settings do not apply for Channel 2 when in the Overlay mode

6.4.1 Setting the Mic Effects



The Mic effect audio settings apply to Channel 1 only.

Setting	Function	
Select Mic1 , Mic 2 (and then set the parameters below which are specific per microphone) or set Line Mute to On or Off		
Mic Mode	Set the mode to Talkover (see Figure 12) or Mix	
Talkover Settings	Talkover Depth [%]	Slide the progress bar to determine the decrease of the audio level during microphone takeover (press + to further decrease the talkover audio output level; press – to lessen the talkover output audio decrease level)
	Talk Over Trigger [dB]	Slide the progress bar to determine the microphone threshold level that triggers the audio output-level decrease
	Attack Time	Slide the progress bar to set the transition time of the audio level reduction after the signal rises above the threshold level
	Hold Time	Slide the progress bar to define the time period talkover remains active although the signal falls below the threshold level (for a short period of time)
	Release Time	Slide the progress bar to define the transition time for the audio level to return from its reduced level to its normal level after the Hold Time period
Mic Mix	Slide the progress bar to set the microphone mix level	
Mic Volume	Slide the progress bar to set the Mic volume	
Mic Delay	Slide the progress bar to set the microphone delay time: 1 to 40ms	
Mic Mute	Set to On or Off	

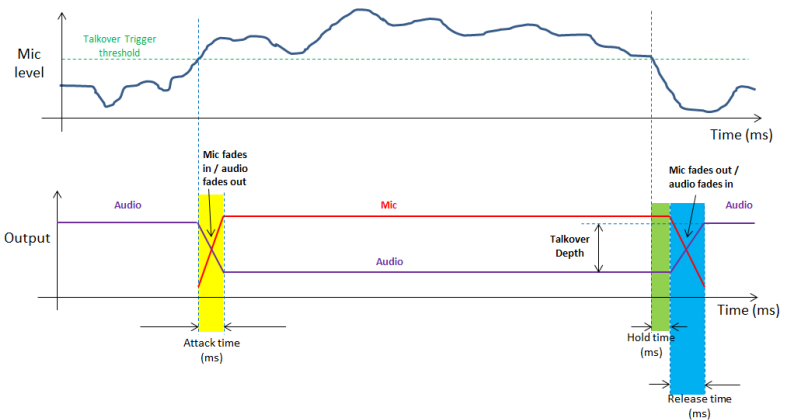

- **Attack time:** The transition time of the audio level reduction after the signal rises above the threshold level
- **Hold time:** The time period talkover remains active although the signal falls below the threshold level (for a short period of time)
- **Release time:** The transition time for the audio level to return from its reduced level to its normal level after the Hold Time period

Figure 12: Talkover Mode

6.4.2 Selecting the Correct Aspect Ratio

You can configure the aspect ratio of any output image to fit your application. The **VP-778** offers four different aspect ratio settings: Follow Input, Follow Output, Best Fit and Letterbox. Here is how each of these settings works.

FOLLOW INPUT – The aspect ratio and resolution of the input video or graphics signal are both preserved (no scaling). For example, a composite video image with a 4:3 aspect ratio will appear with the same aspect ratio on a 1080p (16:9) output image, surrounded by black bars



FOLLOW OUTPUT – The aspect ratio and resolution of the input signal is re-sized to precisely match the aspect ratio and resolution of the **VP-778** output signal. This may result in some distortion to the input signal images

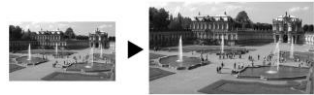

BEST FIT – This setting re-sizes the video or graphics input signal to "best fit" the output resolution while maintaining the aspect ratio of the input signal. For example, a composite video signal (4:3 aspect ratio) will "best fit" to the top and bottom of a widescreen output image, resulting in black pillars on either side.



LETTERBOX – This setting compresses the top and bottom edges of the input signal, but fills the width of the screen. For example, to preserve a widescreen film image on a 4:3 display.



6.4.3 Window Customization

Window customization lets you change the size and position of a selected window.

In the following examples, PiP Window Control is selected, but the same procedure applies to Main Window Control.



Note that you can also customize the window size and position via the "Y" commands (see [Section 14.2](#)) or protocol 3000 (see [Section 14.4](#)).

6.4.3.1 Changing the Size of the Main and/or PiP Window

Use the H Width and V Height to change the size of the window using the + and – buttons on the front panel or remote control transmitter (as illustrated in [Figure 13](#)).

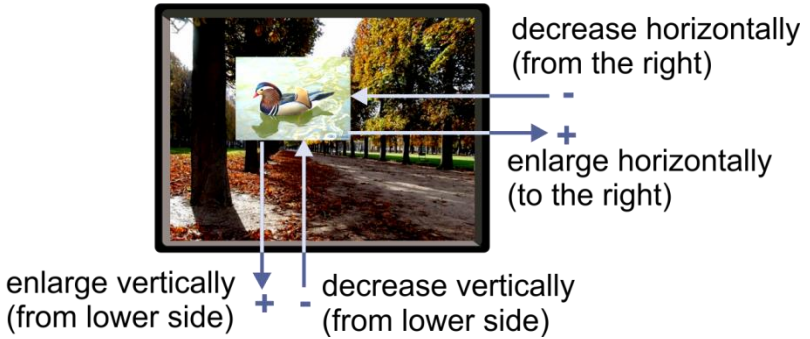

Figure 13: Changing the Size of the Window

To change the size of the window:

1. Check that window control is set as required (for example, PiP Window Control).
2. Select Window Customization (see [Figure 17](#)).
3. Select H width (an OSD slide bar appears) and press + to increase the width, or – to decrease the width, see [Figure 14](#).

The following example shows how to increase the width of the window

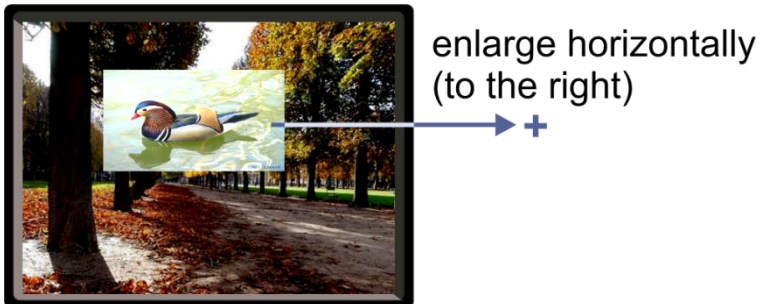

Figure 14: Increasing the Width

4. Select V Height (an OSD slide bar appears) and press + to increase the height, or – to decrease the height, see [Figure 15](#).

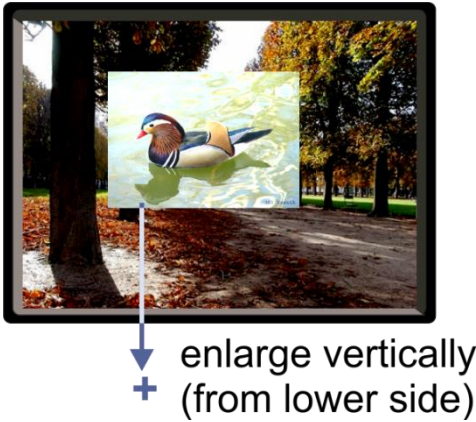

Figure 15: Increasing the Height

6.4.3.2 Moving the Position of the Main and/or PiP Window

Use the H Position and V Position items in the OSD to change the position of the window using the + and – buttons on the front panel or remote control transmitter (as illustrated in [Figure 16](#)).

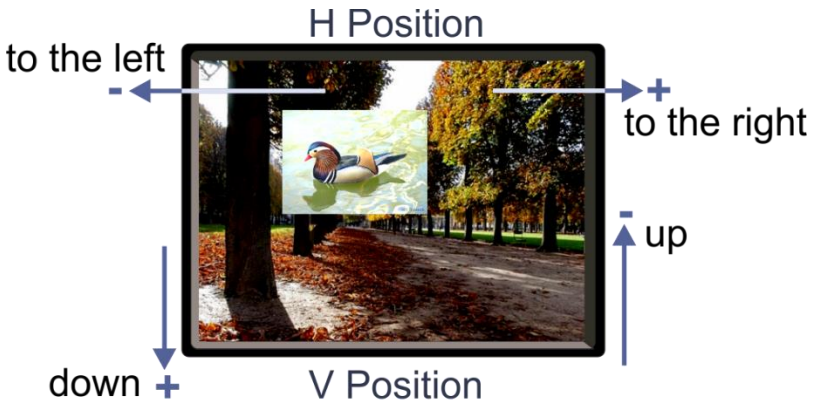

Figure 16: Positioning the Window

To move the position of the window:

1. Check that window control is set as required (for example, PiP Window Control).
2. Select Window Customization.

The following Window appears:

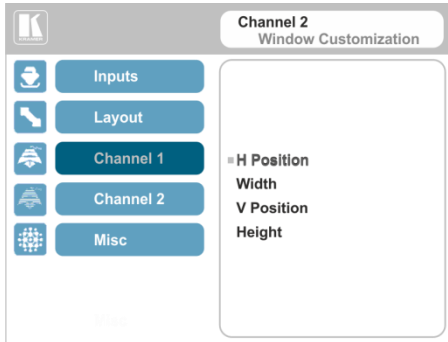

Figure 17: Window Customization

3. To move the picture to the right, select H Position.

An OSD slide bar appears:

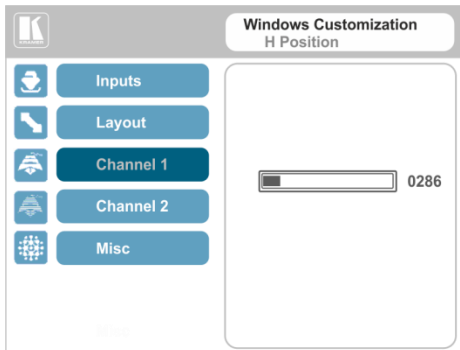

Figure 18: H-Position Slide Bar

4. Press the +/- buttons to move the PiP window horizontally.
Use the V Position menu item in the same way to move the PiP vertically, see [Figure 19](#).



Figure 19: Moving the PiP Window



The sequence in which you change the size and position of the window is insignificant, as long as you make sure that the resized image does not go beyond the window boundaries.

6.5 Misc Menu

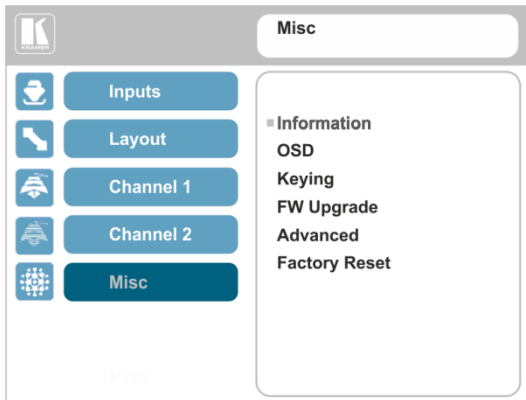



Figure 20: Misc Menu

Setting	Function	
Information	<p>Channel 1 and Channel 2 information – (input selected, input resolution, FH, FV and output resolution) If the selected output is the native output resolution, it will be displayed under "Native Output" (the master connection will also appear, before "Native Output") ; in case of an explicit output resolution the title will be "Output:" If the input video is encrypted, an HDCP icon appears next to the input information</p> <p>FW Versions – shows the firmware versions and update date and time Network – shows the IP address, Netmask, Gateway and DHCP status (ON or OFF) HDBT – Firmware shows the firmware version ID, the version date, the firmware and hardware type and the active bank per HDBT port. Status – shows the port status, including the link status, the cable length, the quality of the signal and so on.</p>	
OSD	H Position	Slide the progress bar to set the horizontal position of the OSD
	V Position	Slide the progress bar to set the vertical position of the OSD
	Transparency	Set the transparency to On or Off
	Gain	Slide the progress bar to set the transparency level (once transparency is set to On)
	Bias	Slide the progress bar to set the transparency level
	Timeout	Set to 30 seconds before OSD timeout, 60 seconds before OSD timeout or OFF (Off means that the OSD appears continuously)
Keying	Chroma Keying Red	Slide the progress bar to set the threshold value of the red components for chroma keying
	Chroma Keying Green	Slide the progress bar to set the threshold value of the green components for chroma keying
	Chroma Keying Blue	Slide the progress bar to set the threshold value of the blue components for chroma keying
		Note that the combination of threshold values (for red, green and blue) determines the chroma keying threshold. Any image with combined values of red, green and blue that are below this threshold will become transparent when chroma keying is enabled (see below).
	Chroma Keying	Set to On or Off to enable/disable chroma keying Note that this feature is available in dual windows mode
	Luma Keying	To turn the keying on the PiP window On or Off (see Section 6.5.1) Note that this feature is available in overlay mode dual windows
FW Upgrade	Upgrade	Select to upgrade the firmware (see Section 12.1)
	Rollback	Select to return to the previous firmware revision (see Section 12.2)
Advanced		
Alert System	N/A	
Port Tunneling	Port Settings	Slide the progress bar to set the Port Type to UDP or TCP and set the Port Number (0 to 64000)
	Uart Setting	Baudrate – 1200, 2400, 4800, 9600, 19200, 38400, 57600 or 115200
		Data Bits – set the data bits: 5, 6, 7 or 8
		Parity – set to None, Odd, Even, Mark or Space
	Stop Bits – set to 1 or 2	
Serial Matrix	Connection 1-8	For each connection, set the source: Port Tunneling, DATA, HDBT-IN1, HDBT-IN2, HDBT-OUT1, HDBT-OUT2 or None Set the Destination: Port Tunneling, DATA, HDBT-IN1, HDBT-IN2, HDBT-OUT1, HDBT-OUT2 or None
	Disconnect All	Disconnect all the port tunneling connections
Power Amplifier	Set the power amplifier (SPKR OUT) level to Off or to levels 1 to 4 This submenu item is specific for the power amplifier on top of the general volume level	

Setting	Function
USR KeyPad	<p>For USR1 / USR2 select:</p> <p>Setup the keypad parameters for a programmable serial command to pass to a selected destination (with a single press of a USR button), see Section 8.1.4.</p> <p>Baudrate – 1200, 2400, 4800, 9600, 19200, 38400, 57600 or 115200</p> <p>Data Bits – set the data bits: 5, 6, 7 or 8</p> <p>Parity – set to None, Odd, Even, Mark or Space</p> <p>Stop Bits set to 1 or 2</p> <p>Destination – Port Tunneling, DATA, HDBT-IN1, HDBT-IN2, HDBT-OUT1, HDBT-OUT2, All or None</p> <p>Data Display – displays the command data as selected from the protocol</p> <p>Launch – execute the command (same as pressing a USR button)</p>
Factory Reset	<p>Reset to factory default values (see Section 13.1).</p> <p>Select Including ETH to perform a full factory reset or Excluding ETH to reset without ETH parameters.</p> <p>Once Factory Reset is selected, a countdown appears, letting you cancel the process and revert to the previous state</p> <div data-bbox="364 491 431 558" style="display: inline-block; vertical-align: middle;">  </div> <p>DO NOT turn the machine off during the factory reset process.</p> <p>The factory reset process takes up to 3 minutes in which all the front panel button lights turn off (except for the PANEL LOCK button) and then turn on again; the image on the displays reappears and only then you can turn the machine off if required</p>

6.5.1 The Luma Keying Feature

The luma keying feature lets you display the Channel 2 window (the key image) as semi-transparent over the Channel 1 window. This feature can be used to have the Channel 2 window display a static or dynamic logo, for example, which will appear on a transparent background.

To apply the luma keying feature, first set the Channel 2 window to the desired size and location and then turn luma keying On. The Channel 2 image will show without its background.

The lower the luminance in the Channel 2 window, the more transparent it becomes, thus letting the Channel 1 window image show. The higher the luminance, the less transparent it becomes, not letting the Channel 1 window show through. To use this feature it is recommended to set the Channel 2 image as follows: use low-luminance colors for the background (the key image portion) and high-luminance colors for the logo.

7 VP-778 Layout

The **VP-778** can function in two modes, the:

- Transition mode, see [Section 7.1](#)
- Overlay mode (for example, PiP), see [Section 7.2](#)

The operation modes are set by selecting the display Mode via the Layout menu (see [Section 6.3](#)).

7.1 Transition Mode

In the transition mode you can setup the input, view it via the Channel 2 output and then switch it to the Channel 1 output.

The **VP-778** has two output channels (Channel 1 and Channel 2). Each channel includes an HDMI connector and an HDBT port: Each of these channels functions independently. An input is routed to the Channel 1 outputs by pressing that CH 1 INPUT front panel button. In the same way pressing a CH 2 INPUT front panel button will route that input to the Channel 2 outputs.

Use the Channel 2 outputs to:

- See how the scaled output looks before displaying live during a presentation
- Harmonize the transition to the Channel 2 output after determining the look and feel
- Use the OSD menu to make adjustments and choose the settings

When in the transition mode, you can set the speed of the transition; determine the type of the transition (Swap or Follow) and the transition effect (Cut or Fade) via the OSD menu (see, [Section 6.3](#)).

For example, select **Cut** for an instantaneous transition from the Channel 2 output to Channel 1 and check **Swap** to interchange Channel 2 with Channel 1.

To switch the inputs in the transition mode via the OSD menu, you need to set the audio signal, define the effects and select the input:

1. In the Channel 2>Advance>Audio, set the Audio signal:
 - Set either AFV for the audio to follow the video, or an analog input from 1 to 8
 - If AFV was selected, set that audio signal to be embedded or analog
 - Set the output volume, bass, mid, treble, balance and lip sync
2. In the Layout menu, set the display mode (for example, Transition).
3. Define the transition settings: Speed, Mode, Effect and Direction.
4. In the Channel 2 menu, select an Input.
5. In the Layout menu select Take to carry out the transition.

To switch the inputs in the transition mode via the front panel buttons:

1. In the Channel 2>Advance>Audio menu, set the Audio signal:
 - Set either AFV for the audio to follow the video, or an analog input from 1 to 8
 - If AFV was selected, set that audio signal to be embedded or analog
 - Set the output volume, bass, mid, treble, balance and lip sync
2. In the Layout menu, set the display mode (for example, Transition).
3. Define the transition settings: Speed, Mode, Effect and Direction.
4. Press the desired CH 2 INPUT front panel button.
5. Press ENTER to carry out the transition.

To set the channel 1 input, repeat the above procedures using the Channel 2 menu.

If the transition mode is set to Swap, the Channel 1 and Channel 2 inputs switch places. If Follow was selected, the Channel 1 input setting will follow the Channel 2 setting and both will display the same input.

7.2 Overlay Mode

In the Overlay mode both outputs are identical and can display a single image (single window display mode), two images one over the other, two images side by side (dual window display mode) or customized window settings.

A selected CH 1 input appears as the main image in a dual window display mode (such as PiP) or as the only image in a single window display mode.

A selected CH 2 input will appear as the PiP window in the dual window display mode and will not appear at all in the single window display mode.

The overlay settings item in the Layout menu (see [Section 6.3](#)) lets you set a Single Window, Picture in Picture (PiP), Picture + Picture (PoP) or Split images. For example, you can show a live video window on top of a graphic background, or show two images on screen of the same input channel. The PiP window appears even if no input signals are connected. In this case the PiP and Main windows appear as set in Channel 1/2>Advanced>No Signal?>Gray/Blue/Black.

The preset PiP configurations are available:

Picture-in-Picture, with a smaller PiP window superimposed over a full main window image

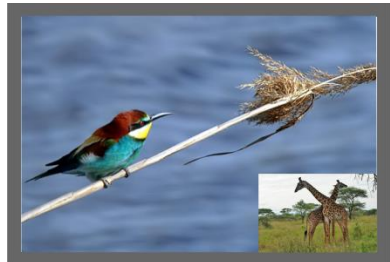

Picture + Picture, where both images appear side-by-side and the aspect ratios of both images are maintained

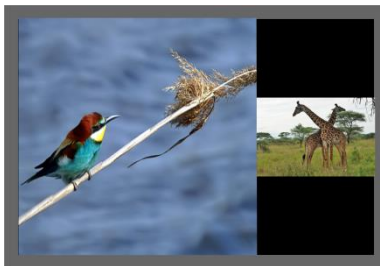

Split, where both images are placed side-by-side with the same height

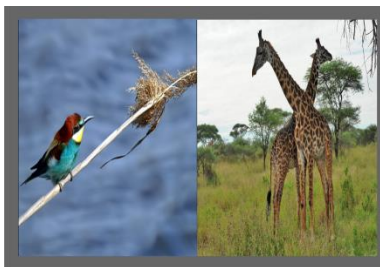

Customized Single, where the size and position of a single image appears as defined in Channel 1>Window Customization.

Customized Dual, where the size and position of both images appear as defined in Channel 1>Window Customization and in Channel 2>Window Customization



You can superimpose any input type over any or the same input.

If the HDMI signal is HDCP protected, it can appear on HDMI and HDBT outputs that are connected to supported HDCP compliant displays. However, it cannot appear on a display that is not HDCP compliant and will show a green screen instead.

7.2.1 Setting the PiP

To set the PiP window in the Overlay mode:

1. In the Layout menu select Overlay Settings.
When in the Overlay display mode
2. Select the type of image you want displayed: Picture in Picture, Picture + Picture, Split or Single Window.

7.2.1.1 Selecting the PiP Source via the Front Panel Buttons

When in the Overlay mode (set only via the OSD menu, see [Section 6.3](#)) select the main window by pressing a CH 1 input front panel button and select the PiP window by pressing a CH 2 front panel button (see [Figure 1](#)).



Figure 21: VGA superimposed over HDMI

7.2.1.2 Selecting the PiP Source via the IR Remote Control Transmitter

When in the Overlay mode press an OUT 1 button to select the main window and press ENTER; press an OUT 2 button to select the PiP window (see [Section 8.5](#)).

7.2.1.3 Selecting the Channel 1/Channel 2 Source via the OSD Menu



You can select an input source only after you set the Display Mode to the Overlay Mode (see [Section 6.3](#)).

To set the Channel 1/Channel 2 source via the OSD menu:

1. Press the MENU button to access the OSD menu.
2. In the Layout menu set Display Mode to Overlay.
3. In Overlay Settings set the image display to any of the dual window options or to single window.
4. In the Channel 1/Channel 2 menu, select Source.
5. Select an input (from 1 to 8).
6. Press the ENTER button.
7. Press the MENU a few times until you exit the OSD menu (changes are saved upon exit).

8 Controlling the VP-778

The **VP-778** can be controlled via:

- The front panel buttons (see [Section 8.1](#))
- The OSD menu (see [Section 6](#))
- The embedded web pages (see [Section 9](#))
- The infrared remote control transmitter (see [Section 8.5](#))

8.1 Controlling via the Front Panel Buttons

The **VP-778** includes the following front panel buttons:

- Input selector buttons for selecting the required input: HDMI (1 to 4), DVI-U (1 and 2) and HDBT (1 and 2), see [Section 3.4](#)
- Mode button to select AFV, Video or Audio switching
- Separate FREEZE and BLANK buttons for each channel (note, these buttons illuminate when selected)
- Two user buttons, USR (1 and 2), which can be configured via the OSD menu and the protocol commands (for example, to turn a projector on and off), see [Section 8.1.4](#).
- MENU and ENTER buttons, as well as left, right, up, and down arrow buttons
- Output volume up (+) and down (-) buttons (when not in the OSD mode)
- RESET TO XGA/720p and PANEL LOCK buttons

8.1.1 Using the Mode Buttons

Press the MODE button to toggle between the AFV (green LED) mode, the VIDEO (orange LED) mode and the Audio (red LED) mode. When selected, each mode defines the function of the CH 1 and CH 2 front panel buttons when next pressing the front panel buttons. That is, when in the:

- AFV mode, press an INPUT button to select the video together with its audio signal
- VIDEO mode, to select the video inputs only
- AUDIO mode to select the audio inputs only



Note that the MODE button indicates the status for the next press on the front panel input buttons only.

The input buttons light in accordance with the selected modes:



A bright green button indicates that both the audio and video signals of that input are selected (AFV with **embedded** audio signal)



A medium green button indicates that both the audio and video signals of that input are selected (AFV with **analog** audio signal)



An orange button indicates that only the video signal of that input is selected



A red button indicates that only the audio signal of that input is selected



A dim button indicates an ineffective signal (for all button colors)



A dim blue button indicating Auto switching

The following example shows how to use the front panel buttons to switch inputs:

CH 1 **DVI-U2** and CH 2 **DVI-U1** are selected. The AFV mode is selected (CH 1-embedded audio signal; CH 2 analog audio signal)

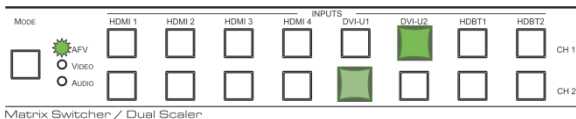

Press the **MODE** button to set it to the **VIDEO** mode. This will affect the next press of input buttons

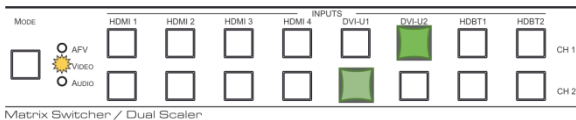

Press CH 1 **HDMI4** – the video only switches to **HDMI4** and the audio remains in **DVI-U2**.

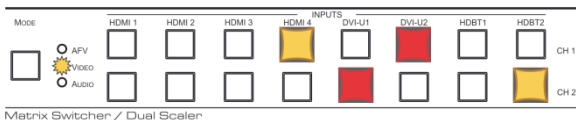

Press CH 2 **HDBT2** – the video only switches to **HDBT2** and the audio remains in **DVI-U1**



Press the **MODE** button to set it to the **AUDIO** mode. This will affect the next press of input buttons

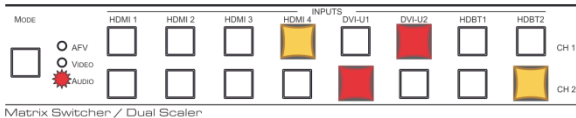

Press CH 1 **HDMI1** – the audio only switches to **HDMI1** and the video remains in **HDMI4**.

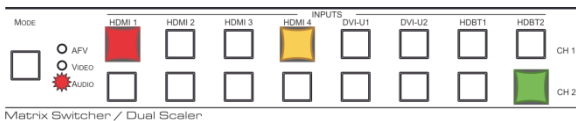

Press CH 2 **HDBT2** – the audio only switches to **HDBT2** and the video remains in **HDBT2** so that audio follows video and the button light green



8.1.2 Button Behavior in the Transition Mode

When in the Transition mode, pressing the ENTER front panel button in the Swap mode will swap the CH 1 and CH 2 inputs as follows, from:

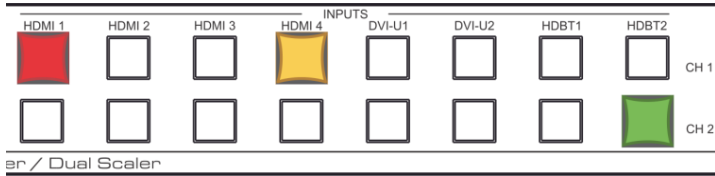

TO

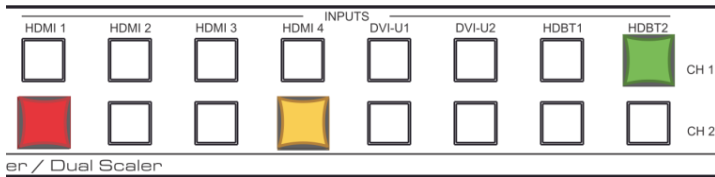

When in the Transition mode, pressing the ENTER front panel button in the Follow mode will switch the CH 1 inputs to follow the CH 2 inputs:

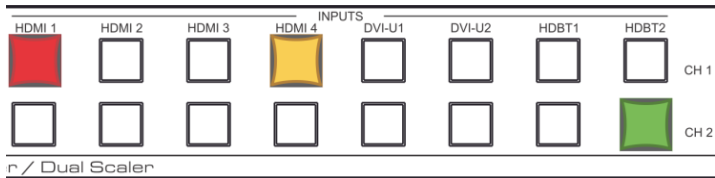

TO

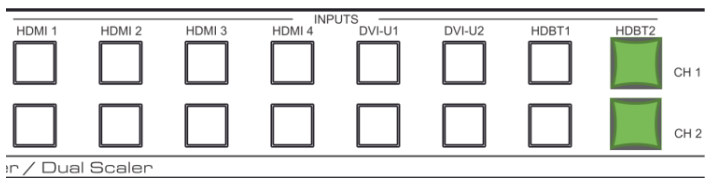

8.1.3 Button Behavior in the Overlay Mode

When in the overlay mode, the **VP-778** does not pass the CH 2 audio signal to the output.

In the Overlay dual mode the CH 2 audio input button is dimmed:

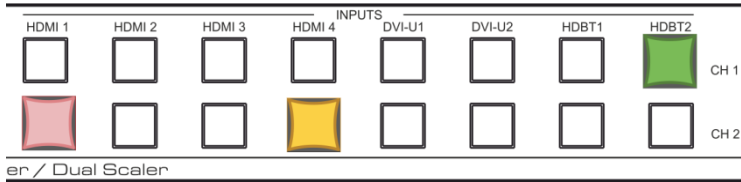

When in the Overlay mode, in the Single Window setting (see [Section 7.2](#)), the CH 2 buttons (Audio, Video and AFV) appear dim, as illustrated in the following examples:

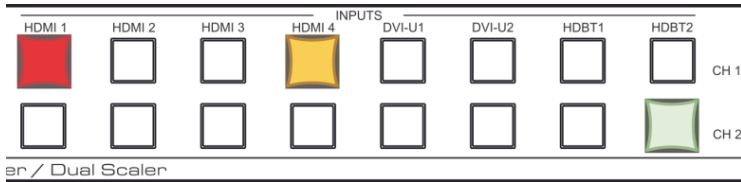

Or

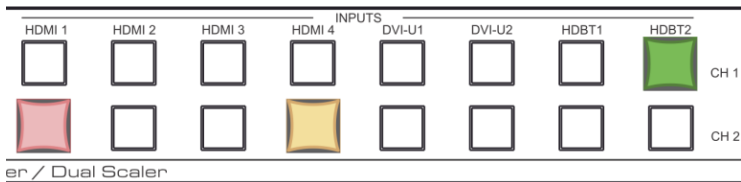

If you want to adjust the image of a selected input in a window, press that input button again (up to 3 times) for fast tuning. Pressing that input button for the fourth time initiates full tuning of the window.

8.1.4 USR Keypad Buttons

Use USR keypad buttons to launch a specific programmable serial command to a selected destination (with a single press of a USR button).

To configure, program and launch a serial command using a USR Keypad button (for example USR 1):

1. Configure the USR Keypad communication parameters (Baud rate, data bits, parity, stop bits and the destination to which the command is sent) via:
 - OSD menu – in the Misc menu, select Advance>USR KeyPad, see [Section 6.5](#).
 - Y commands – select Misc>Advance>USR KeyPad, see table in [Section 14.2.2.4](#).
 - Protocol 3000 commands – see the **CBIN** command in [Section 14.7.4.3](#).
2. Program the USR Keypad button command via the **DBIN** protocol 3000 command (see [Section 14.7.4.4](#)).
You can view the command via the **Data Display** item in the USR Keypad menu.
3. Launch the USR Keypad command in any of the following ways:
 - Pressing **USR 1** on the **VP-778** front panel or IR remote control transmitter.
 - Selecting Misc>Advance>USR KeyPad>Launch via Y commands, see table in [Section 14.7.4.4](#).
 - Clicking **Launch** in the USR Keypad OSD menu, see [Section 6.5](#).
 - Sending the **BIN** command, see [Section 14.7.4.5](#).



The **BIN** command can also be used to launch a one-time custom command that overrides the **DBIN** programmed command.

8.2 Connecting to the VP-778 via RS-232

The **VP-778** features two RS-232 ports:

- RS-232 DATA to pass data to and from the machines that are connected to the HDBT connectors
- RS-232 CONTROL to control the **VP-778**

Connect the RS-232 terminal block on the rear panel of the **VP-778** to a PC/controller, as follows (see [Figure 22](#)):

- TX pin to Pin 2
- RX pin to Pin 3
- GND pin to Pin 5

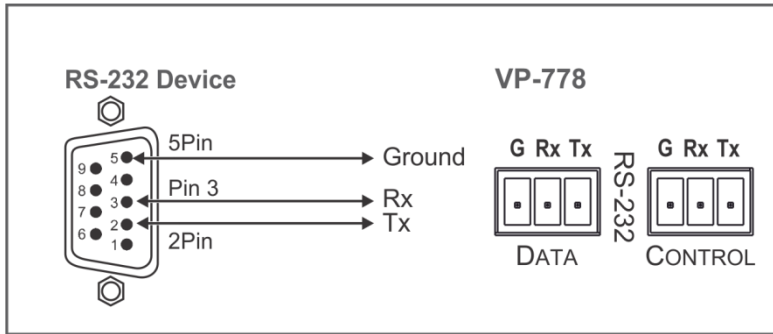

Figure 22: RS-232 Connection

8.3 Connecting the VP-778 via the ETHERNET Port

You can connect to the **VP-778** via Ethernet using either of the following methods:

- Directly to the PC using a crossover cable (see [Section 8.3.1](#))
- Via a network hub, switch, or router, using a straight-through cable (see [Section 8.3.1.1](#))



If you want to connect via a router and your IT system is based on IPv6, speak to your IT department for specific installation instructions.

8.3.1 Connecting the Ethernet Port Directly to a PC

You can connect the Ethernet port of the **VP-778** directly to the Ethernet port on your PC using a crossover cable with RJ-45 connectors.



This type of connection is recommended for identifying the **VP-778** with the factory configured default IP address.

After connecting the VP-778 to the Ethernet port, configure your PC as follows:

1. Click **Start > Control Panel > Network and Sharing Center**.
2. Click **Change Adapter Settings**.
3. Highlight the network adapter you want to use to connect to the device and click **Change settings of this connection**.

The Local Area Connection Properties window for the selected network adapter appears as shown in [Figure 23](#).

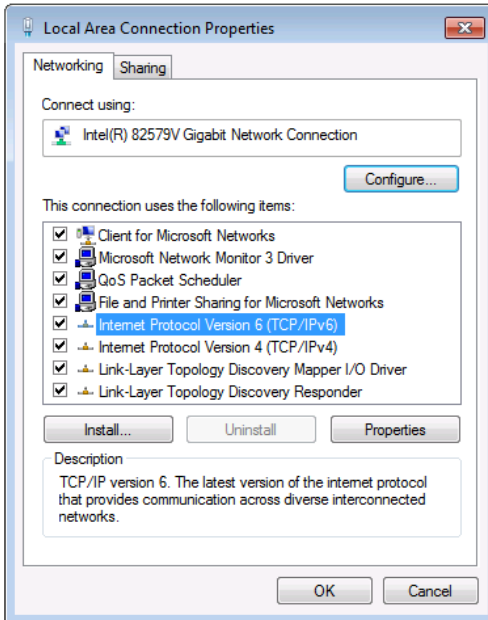

Figure 23: Local Area Connection Properties Window

4. Highlight either **Internet Protocol Version 6 (TCP/IPv6)** or **Internet Protocol Version 4 (TCP/IPv4)** depending on the requirements of your IT system.
5. Click **Properties**.

The Internet Protocol Properties window relevant to your IT system appears as shown in [Figure 24](#) or [Figure 25](#).

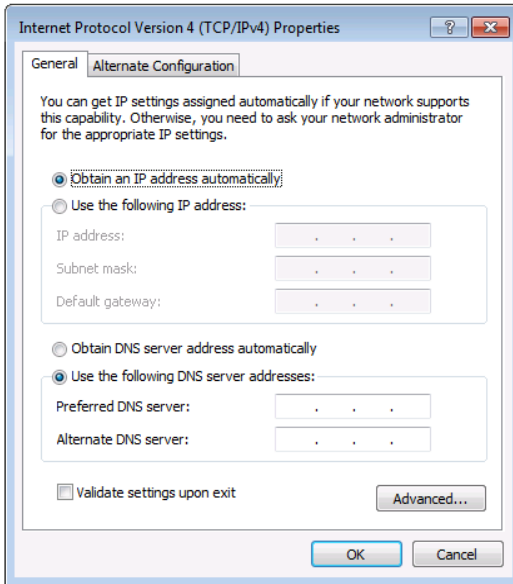

Figure 24: Internet Protocol Version 4 Properties Window

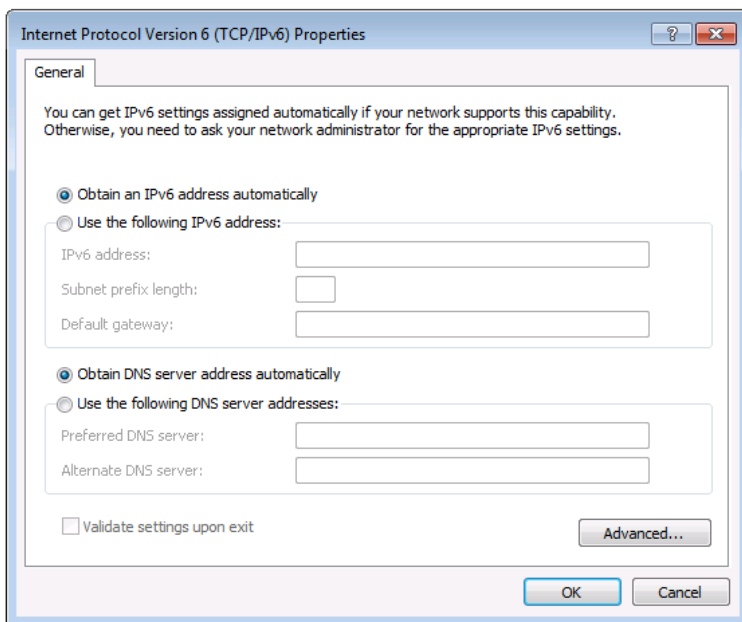

Figure 25: Internet Protocol Version 6 Properties Window

6. Select **Use the following IP Address** for static IP addressing and fill in the details as shown in [Figure 26](#).
For TCP/IPv4 you can use any IP address in the range 192.168.1.1 to 192.168.1.255 (excluding 192.168.1.39) that is provided by your IT department.

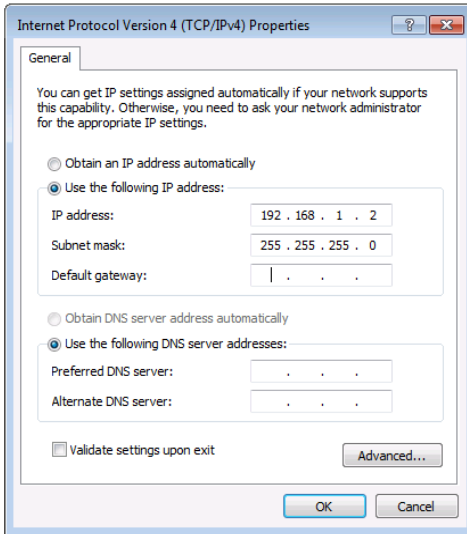

Figure 26: Internet Protocol Properties Window

7. Click **OK**.
8. Click **Close**.

8.3.1.1 Connecting the ETHERNET Port via a Network Hub or Switch

You can connect the Ethernet port of the **VP-778** to the Ethernet port on a network hub or network router, via a straight-through cable with RJ-45 connectors.

8.4 Controlling via the OSD Menu

You can change PiP Window parameters, main window parameters and entire system parameters via the OSD menu, as described in [Section 6](#).

8.5 Controlling via the Infrared Remote Control Transmitter

You can control the **VP-778** from the infrared remote control transmitter:



Figure 27: Infrared Remote Control Transmitter

Keys		Function
POWER		Toggle the power save mode ON or OFF
RESET		Press to reset to the default resolution (toggles between RESET TO XGA and 720p)
Inputs to switch to OUT 1	HDMI1	Select the HDMI 1 input
	HDMI2	Select the HDMI 2 input
	HDMI3	Select the HDMI 3 input
	HDMI4	Select the HDMI 4 input
	DVI1	Select the DVI 1 input
	DVI2	Select the DVI 2 input
	HDBT1	Select the HDBT 1 input
	HDBT2	Select the HDBT 2 input
OUT 1 Control	FREEZE	Freeze/unfreeze the output video image
	BLANK	Toggle between a blank screen (black) and the output video image
	MUTE	Toggle between muting (blocking out the sound) and enabling the audio output
USR1		Press to launch a programmed command, see Section 8.1.4
USR2		Press to launch a programmed command, see Section 8.1.4
		Press ENTER to access menu levels (when in the OSD) Use the up and down arrows to adjust numerical values and adjust the output volume level (when not within the OSD)
MENU		Enter/Exit the OSD menu and return to the previous menu level
LOCK		Lock the front panel buttons
Inputs to switch to OUT 2	HDMI1	Select the HDMI 1 input
	HDMI2	Select the HDMI 2 input
	HDMI3	Select the HDMI 3 input
	HDMI4	Select the HDMI 4 input
	DVI1	Select the DVI 1 input
	DVI2	Select the DVI 2 input
	HDBT1	Select the HDBT 1 input
	HDBT2	Select the HDBT 2 input
OUT 2 Control	FREEZE	Freeze/unfreeze the output video image
	BLANK	Toggle between a blank screen (black) and the output video image
	MUTE	Toggle between muting (blocking out the sound) and enabling the audio output

8.5.1 Using the IR Transmitter

You can use the IR transmitter to control the machine via the built-in IR receiver on the front panel or, instead, via an optional external IR receiver. The external IR receiver can be located up to 15 meters away from the machine. This distance can be extended to up to 60 meters when used with three IR extension cables.

Before using the external IR receiver, be sure to arrange for your Kramer dealer to insert the internal IR connection cable with the 3.5mm connector that fits into the REMOTE IR opening on the rear panel. Connect the external IR receiver to the REMOTE IR 3.5mm connector.

8.5.1.1 Ethernet Port Configuration and Control

Use the Kramer **K-Upload** software to configure the **VP-778** and the web pages to control it via the Ethernet (for example, set the IP address).



Do not use **K-Upload** to upgrade the firmware



The latest version of **K-Upload** and installation instructions can be downloaded from the Kramer Web site at www.kramerav.com/support/product_downloads.asp

9 Using the Embedded Web Pages

The **VP-778** can be operated remotely using the embedded web pages. The web pages are accessed using a web browser and an Ethernet connection.

Before attempting to connect:

- Perform the procedures in [Section 8.3](#).
- Ensure that your browser is supported.

The following Web browsers are supported:

Windows 7 and higher:	
Chrome: from version 20 and higher	IE: from 10 and higher
Firefox: from 28 and higher	Edge: from 14 and higher
Mac (PC) Yosemite 10 and higher:	
Chrome: from version 20 and higher	Safari: from 7.1 and higher
iOS 8.0 and higher:	
Chrome: from version 20 and higher	Safari: from 7.1 and higher
Firefox: from 28 and higher	
Android OS 4.4 and higher:	
Chrome: from version 20 and higher	Native

- Make sure that the Web client device (for example, a tablet) resolution supports width > 1000 and height > 615

9.1 Browsing the VP-778 Web Pages

There are six web pages:

- The Routing & Scaling page (see [Section 9.2](#))
- The Transition Settings page (see [Section 9.3](#))
- The Audio Settings page (see [Section 9.4](#))
- The Output Settings page (See [Section 9.5](#))
- The Device Settings page (see [Section 9.6](#))
- The About page (see [Section 9.7](#))

To browse the VP-778 web pages:

1. Open your Internet browser.
2. Type the IP address of the device in the Address bar of your browser. For example, the default IP address:

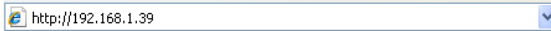

The Routing & Scaling webpage appears.

[Figure 28](#) shows the Routing & Scaling page that is also the first web page. The navigation list on the left shows the available web pages.

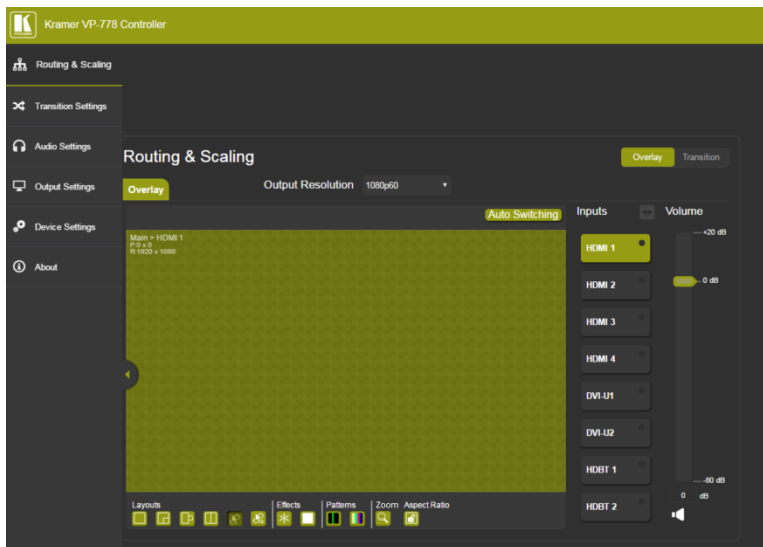



Figure 28: Routing and Scaling Page with Navigation List on Left

Click the arrow to hide the navigation list on the left (note that the page icons remain visible allowing you to select a Web page even if the list is hidden).

Click the  button to view the Web pages in full screen and click  to exit.

9.2 Routing & Scaling the Image

The Routing & Scaling web page enables performing of the following functions (for Channel 1 and Channel 2) which apply to both the Overlay and Transition modes:

- Setting to Overlay or Transition mode (see [Section 9.2.1](#)).
- Selecting an input (see [Section 9.2.2](#)).
- Selecting the output resolution (see [Section 9.2.3](#)).
- Selecting Effects and Test Patterns (see [Section 9.2.4](#)).
- Auto Switching (see [Section 9.2.5](#)).
- Zooming the image (see [Section 9.2.6](#)).
- Setting or muting the output volume (see [Section 9.2.7](#)).

Functions that are specific to the Transition or Overlay modes are specified in sections [9.2.8](#) and [9.2.9](#), respectively.

9.2.1 Setting the Operation Mode

The Routing & Scaling page enables you to set the **VP-778** either to the Transition mode (see [Section 7.1](#)) or the Overlay mode (see [Section 7.2](#)).

To set the operation mode:

1. In the Navigation pane, click **Routing & Scaling**. The Routing & Scaling page appears:

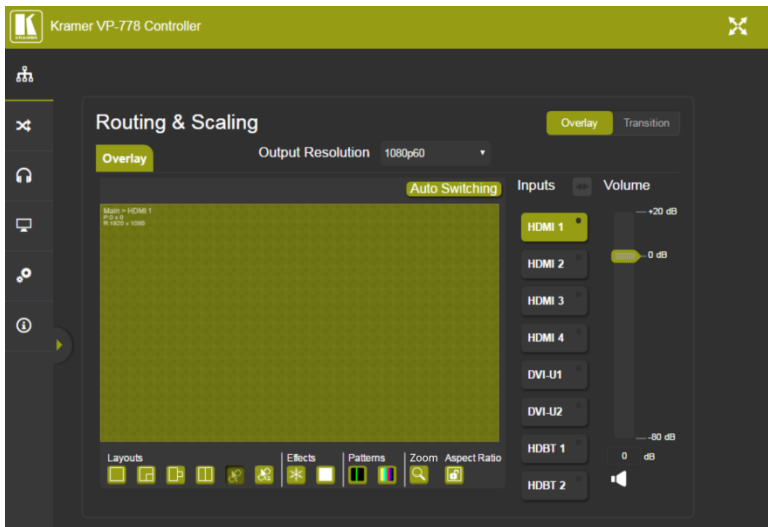
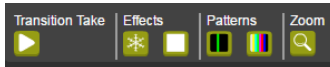

Figure 29: Routing and Scaling Page

2. Click either the Transition or the Overlay button to set the required operation mode.

Note that the lower operation buttons change according to the operation mode:

In the Transition mode:



In the Overlay mode

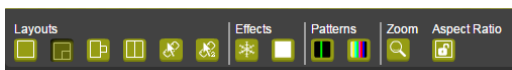

9.2.2 Selecting an Input

An input can be selected separately for CH 1 and CH 2 in the Transition mode or for the Main and PIP in the Overlay mode.

To select an input:

1. In the Navigation pane, click **Routing & Scaling**. The Routing & Scaling page appears.
2. Select an input (from Input 1 to Input 8). If there is an active signal present on the selected input the signal indicator lights green (see Input 4 in [Figure 29](#)).



9.2.3 Setting the Output Resolution

To set the Output Resolution:

1. In the Navigation pane, click **Routing & Scaling**. The Routing & Scaling page appears.
2. Open the Output Resolution drop box and select the desired resolution.

9.2.4 Setting the Effects and Test Patterns

To set the effects:

1. In the Navigation pane, click **Routing & Scaling**. The Routing & Scaling page appears.
2. Click the freeze button  to freeze the image or click  to set a blank display.

To select a test pattern:

1. In the Navigation pane, click **Routing & Scaling**. The Routing & Scaling page appears:
2. Click a test pattern button.

Two patterns are available: the slide bar content (for clear content) and the color bar pattern (for HDCP content). Note that selecting a test pattern disables the Effects buttons.

9.2.5 Auto Switching

To set the auto switching mode:

1. In the Navigation pane, click **Routing & Scaling**. The Routing & Scaling page appears.
2. Click **Auto Switching**.

The following Window Appears:

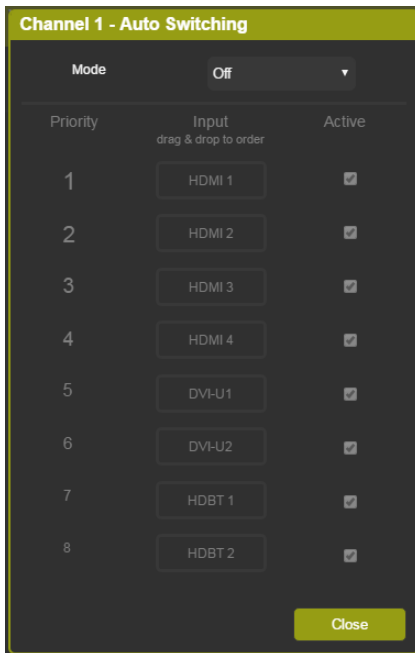

Figure 30: Routing & Scaling Page – Auto Switching Window

3. Open the dropdown list to set the switching mode (Off, Scan or Last Connected).

4. Select the switching mode (for example, select Scan).
The Auto Switching window is enabled:

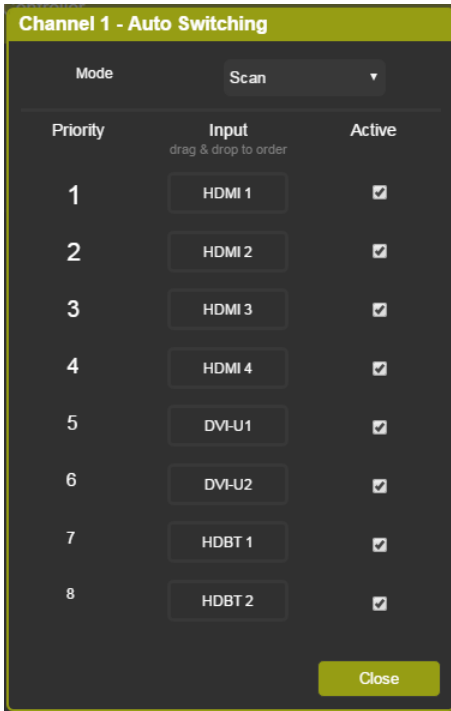

Figure 31: Routing & Scaling Page – Scan Mode

5. Check the inputs that should be active in the scan and uncheck to disable others.

6. Drag and Drop inputs to set them to the desired priority:

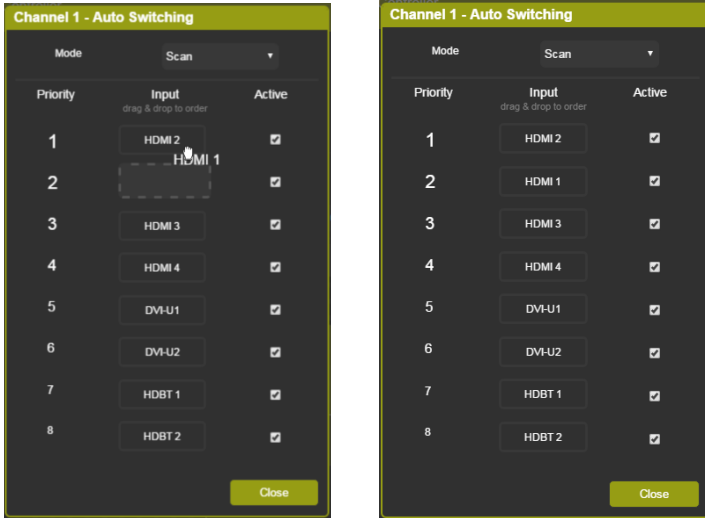

Figure 32: Routing & Scaling Page – Setting Priorities

7. Click **Close**.



In scan mode, as the device scans each of the active (connected) inputs, each of the corresponding input buttons briefly lights blue.

9.2.6 Setting the Zoom

The **Zoom** button lets you zoom the image up to 4000% and shift the image to zoom into a specific area.

Note that if there is no active signal on the input, the Zoom window will not open.

To zoom into the image:

1. In the Navigation pane, click **Routing & Scaling**. The Routing & Scaling page appears.
2. Click the Zoom button.

The PROGRAM ZOOM window appears:

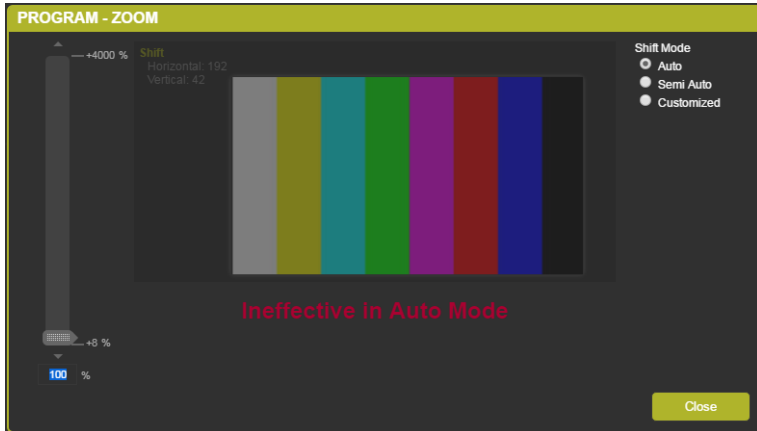

Figure 33: Routing and Scaling Page – PROGRAM – ZOOM Window

Three zooming options are available:

- The Auto mode which automatically sets the Zoom to 100% and places the image correctly on the display.
- The Semi-Auto image in which the zoom and shift that are set manually do not change unless the input resolution is changed In that case the zoom shift mode will return to Auto mode.
- The Customized mode in which the zoom and shift are set manually and do not change even if the source/input resolution are changed.

9.2.7 Setting the Output Volume

To set the Output Volume:

1. In the Navigation pane, click **Routing & Scaling**. The Routing & Scaling page appears.
2. Use the volume slider on the right side to set the output volume and click the speaker button to mute (🔇) or unmute (🔊) the audio output.

9.2.8 Transition mode Specific Functions

In the transition mode, press the Transition Take  button to carry out a transition as defined in [Section 9.3](#).

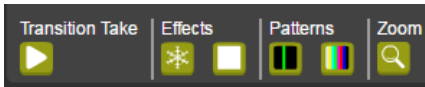

Figure 34: Routing and Scaling Page – Transition Take

9.2.9 Overlay Mode Specific Functions

The Overlay mode enables you to perform the following functions:

- Set the size and the position of the Main and PIP images.
- Set the layout of the Overlay mode.
- Set the customized image size.
- Keep aspect ratio when resizing the image.

To set the size of the Main and PIP images:

1. Drag and pull a horizontal or a vertical arrow to change the size of the width and height of the image, respectively.



Figure 35: Routing and Scaling Page – Changing the Image Size

To set the position of the image:

1. Click and drag the image to its new location.



The size and position of the image are set as the customized image sizes and appear when selecting Customized Single or Customized Dual layouts. The size and position of the image is indicated on the top left side of the image.

To set the Layout:

1. Click the desired layout button: Single Window, Picture in Picture, Picture + Picture, Split or customized (as defined when setting the size and the position of the image):



Figure 36: Routing and Scaling Page – Selecting the Layout

For example, setting the Picture in Picture layout results in the following:



Figure 37: Routing and Scaling Page – Setting the Layout

Setting to customized Dual shows the manually defined images:

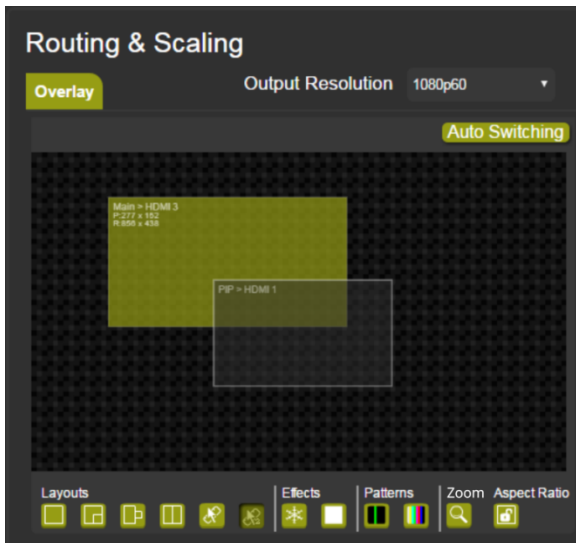

Figure 38: Routing and Scaling Page – Customized Dual Layout

9.3 Transition Settings Page

The Transition Settings page is enabled in the Transition mode:

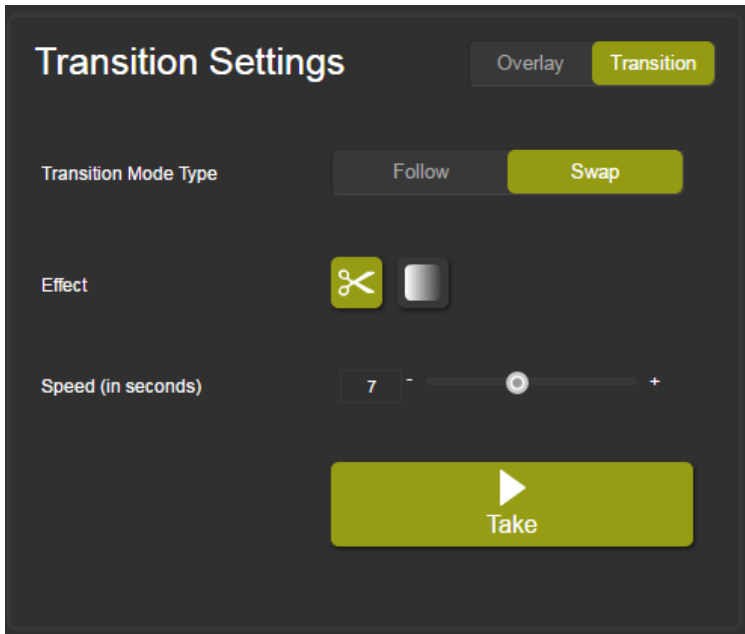

Figure 39: Transition Settings Page

The Transition Settings page allows you to perform the following functions:



- Set the VP-778 to the Transition mode (see [Section 9.2.1](#))
- Set the Transition (see [Section 9.3.1](#))

9.3.1 Transition effects

Set the transition mode type, effect and speed of the transition and then press **Take** to carry out the transition.

9.3.1.1 Setting Transition Effects

To set the transition effects:

1. In the Navigation pane, click **Transition Settings**. The Transition Settings page appears.
Note that the Transition Settings page is enabled only in the Transition mode.
2. Select either Follow or Swap mode.
Follow Mode: Channel 1 input follows the Channel 2 input.
Swap mode: Channel 1 and Channel 2 inputs swap places.
3. Set the transition effect, click cut () or fade ()
4. Set the speed of the transition.
5. Click **Take** to carry out the transition setup.

9.4 Audio Settings Page

The Audio page lets you define the audio parameters in the Overlay and Transition modes and setup the microphones. In the Transition mode you can set the Channel 2 and Channel 1 audio parameters while in the Overlay mode you can set the Main audio parameters.

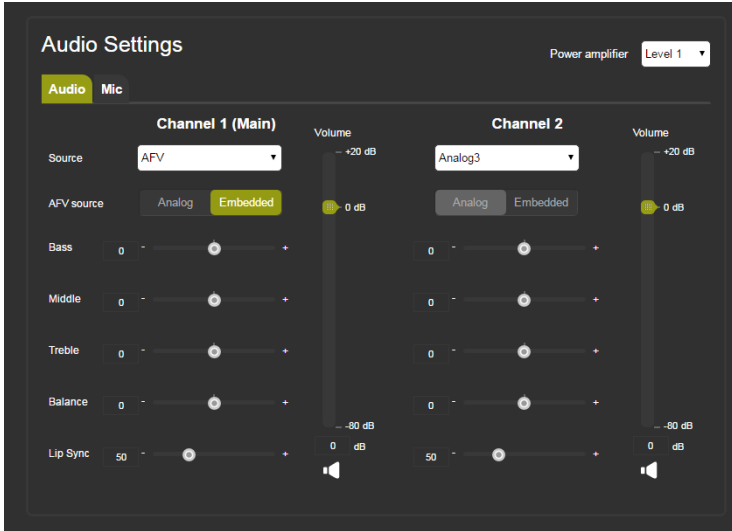

Figure 40: Audio Settings Page

The Audio tab enables performing the following functions:

- Set AFV or audio breakaway mode (see [Section 9.4.1](#)).
- Adjust the Bass, Middle, Treble, balance and Lip Sync (see [Section 9.4.2](#)).
- Adjust the output volume (see [Section 9.4.3](#)).

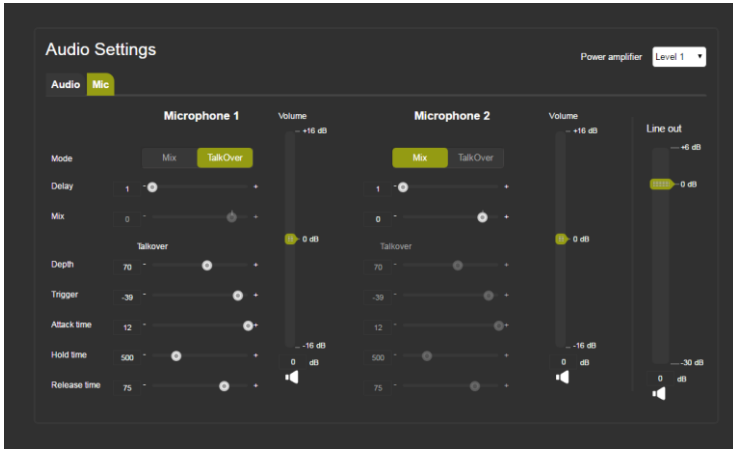

Figure 41: Mic Settings Page

The Mic tab enables performing the following functions for Mic 1 and Mic 2:

- Set to Mix mode or TalkOver mode (see [Section 9.4.4](#)).
- Set the delay (see [Section 9.4.5](#)).
- Set the mix level in Mix mode or the talkover parameters in TalkOver mode (see [Section 9.4.6](#)).
- Adjust the Mic volume (see [Section 9.4.7](#)).

9.4.1 Setting AFV or Breakaway Mode

To set audio operation mode:

1. In the Navigation pane, click **Audio Settings**. The Audio Settings page appears.
2. Select the Audio tab.
3. Set the source to AFV or to any of the 8 analog inputs.



If an analog audio source is selected, the AFV source is disabled and is set to Analog.



9.4.2 Adjusting Audio Parameters

To adjust audio parameters:

1. In the Navigation pane, click **Audio Settings**. The Audio Settings page appears.
2. Select the Audio tab.
3. Use the various sliders to set the audio parameters.

9.4.3 Setting the Output Volume

To set the Output Volume:

1. In the Navigation pane, click **Audio Settings**. The Audio Settings page appears.
2. Select the Audio tab.
3. Use the volume slider on the right side to set the output volume and click the speaker button to mute  or unmute  the audio output.

9.4.4 Setting Microphone Operation Mode

To set the microphones operation mode:

1. In the Navigation pane, click **Audio Settings**. The Audio Settings page appears.
2. Select the Mic tab.
3. Set the operation mode to Mix or TalkOver.

9.4.5 Setting the Delay time

To set the delay time:

1. In the Navigation pane, click **Audio Settings**. The Audio Settings page appears.
2. Select the Mic tab.

3. Set the microphone delay time.



If an analog audio source is selected, the AFV source is disabled and is set to Analog.



9.4.6 Setting Microphone Parameters

To set microphone parameters:

1. In the Navigation pane, click **Audio Settings**. The Audio Settings page appears.
2. Select the Mic tab.
3. In Mix mode, set the Mix level.
On TalkOver mode, set the Depth, Trigger, Attack time Hold time and Release time (for further information see [Section 6.4.1](#)).

9.4.7 Setting the Microphone Volume

To set the Volume:

1. In the Navigation pane, click **Audio Settings**. The Audio Settings page appears.
2. Select the Mic tab.
3. Use the volume slider on the right side to set the Microphone volume and the Line out volume, and click the speaker button to mute () or unmute () the audio output.

9.5 Output Settings Page

The output Settings pages enables to define output parameters:

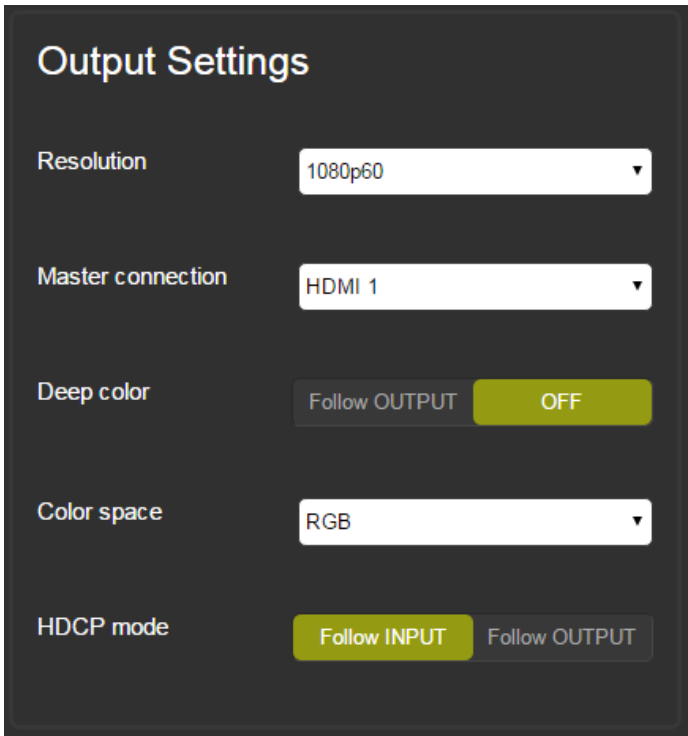

The screenshot shows the 'Output Settings' page with the following configuration options:

- Resolution:** 1080p60
- Master connection:** HDMI 1
- Deep color:** OFF (with 'Follow OUTPUT' as an alternative option)
- Color space:** RGB
- HDCP mode:** Follow INPUT (with 'Follow OUTPUT' as an alternative option)

Figure 42: Output Settings Page

The following functions can be set:

- Output resolution (see [Section 9.2.3](#))
- Master connection (HDMI 1, HDBT 1, HDMI 2 or HDBT 2)
- Deep color settings (Follow Output or Off)
- Color space (RGB, YPbPr422 or YPbPr444)
- HDCP mode (Follow Input or Follow Output)

9.6 Device Settings Page

The device Settings page ([Figure 45](#)) allows you to set the:

- Unit name (type the name and click the Set button)
- Ethernet parameters
- View the Information and HDBT information windows (see [Section 9.6.2](#) and [Section 9.6.3](#))
- Perform factory reset (see [Section 9.6.4](#))

The screenshot shows the 'Device Settings' page with the following configuration details:

Field	Value
Model	VP-778
Unit name	VP-778_333
Serial number	01170120200018
Mac address	02-00-00-00-00-01
DHCP	OFF
IP address	192 . 168 . 1 . 78
Subnet mask	255 . 255 . 0 . 0
Gateway	192 . 168 . 0 . 1

Buttons: Factory Reset, HDBT info, Set (for Unit name and Gateway).

Figure 43: Device Settings Page

9.6.1 Setting the Ethernet Parameters

Generally, when changing the setup, the following message appears:

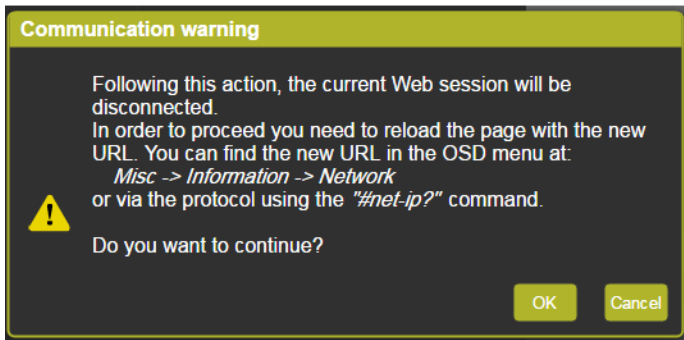

Figure 44: Device Settings Page – Communication Warning

Click **OK** to continue.

DHCP can be set to ON or OFF.

When setting DHCP **OFF**, the DHCP OFF window lets you select the default IP address or a custom IP address:



Figure 45: Device Settings Page – DHCP Window

Click **Apply** to confirm changes.

When setting DHCP **ON**, the following window appears:

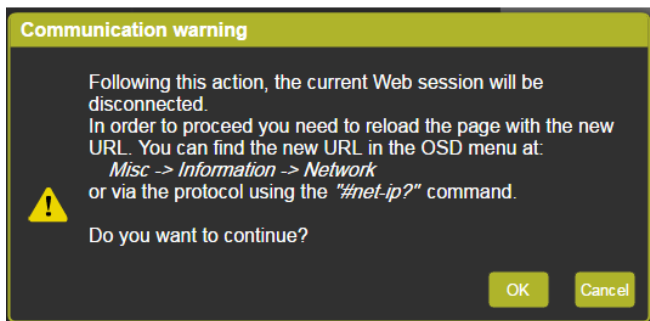

Figure 46: Device Settings Page – DHCP ON Notification

You can retrieve the new IP address via the OSD menu by selecting: **Misc>Information>Network**, and use that new IP Address to reopen the web pages or via the #net-ip? Protocol command (see [Section 14.7.2.4](#)).

9.6.2 Viewing VP-778 Information

Click the Information button () to view the device information:

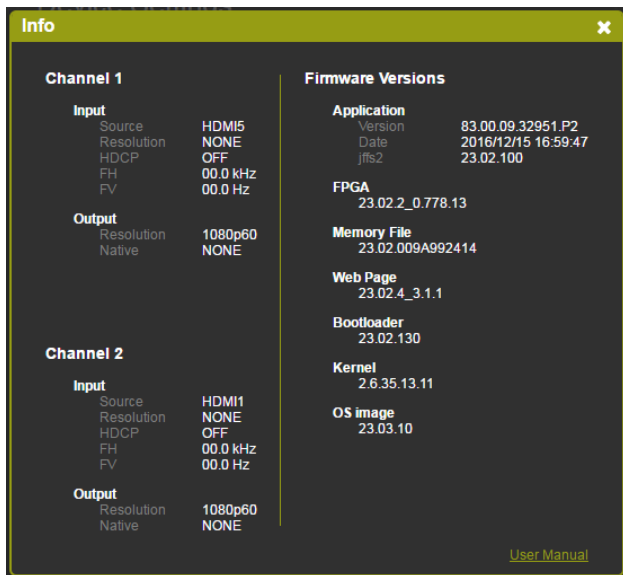

Figure 47: Device Settings Page – Info Window

9.6.3 Viewing HDBT Information

Click **HDBT info** to view the HDBT input and HDBT output information:

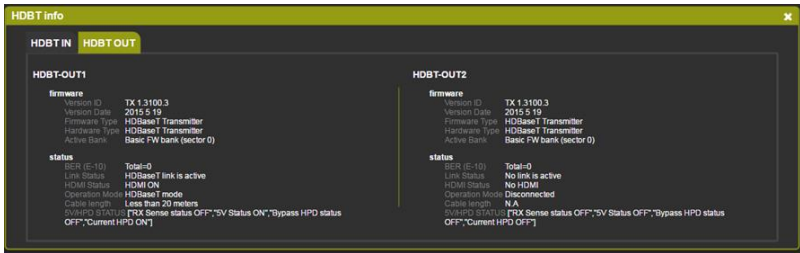

Figure 48: Device Settings Page – HDBT Info Window

9.6.4 Performing Factory Reset

To perform factory reset:

1. In the Navigation pane, click **Device Settings**. The Device Settings page appears.
2. Click **Factory Reset**.

The following message appears:

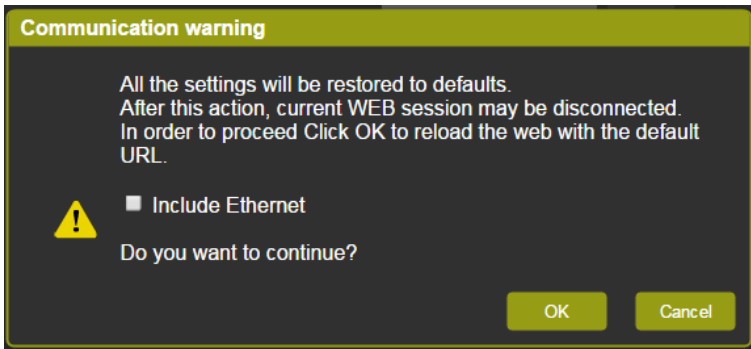

Figure 49: Device Settings Page – Communication Warning

3. Check **Include Ethernet** if you also want to reset Ethernet parameters to their default value.

4. Click **OK**.

The following message appears on the screen:

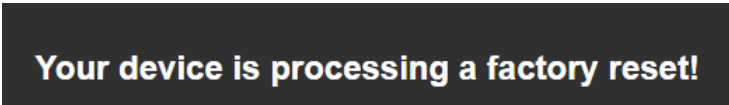

Figure 50: Device Settings Page – Factory Reset Message

9.7 About Page

The **VP-778** About page lets you view the Web page version and Kramer Electronics Ltd details.



Figure 51: About Page

10 Port Tunneling

The port tunneling feature lets you send and receive simple RS-232 signals between a controller and a serial device via the **VP-778** which is connected to the Ethernet and outputs via TP cable.

The example, illustrated in [Figure 52](#), shows a Kramer room controller that is connected to the **VP-778** via the Ethernet. The HDBT OUT connector on the **VP-778** is connected via TP to an HDBT receiver. This HDBT receiver connects to a display via HDMI and RS-232.

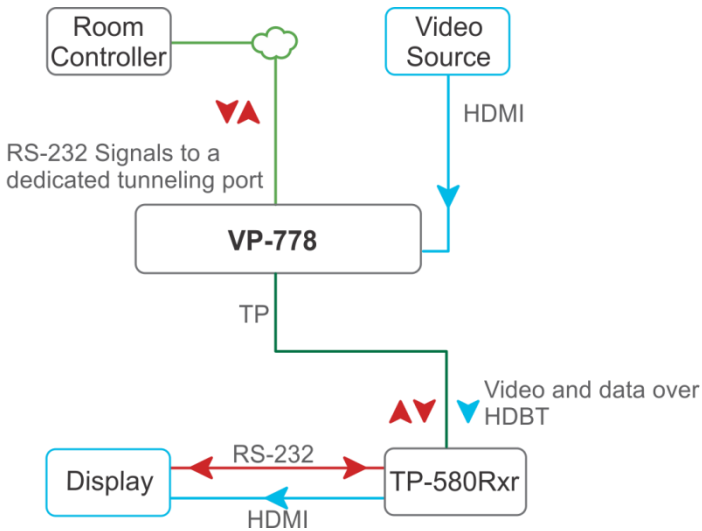

Figure 52: Port Tunneling

The room controller sends RS-232 signals over the Ethernet via a dedicated Tunneling port to the **VP-778**. The **VP-778** sends these signals via TP to a display that is connected to the receiver. This way, control data can flow between the room controller and the display device, tunneling through the **VP-778**.

To setup and activate port tunneling on the **VP-778**:

1. Set the dedicated port tunneling Ethernet connection port type and port number through which the **VP-778** will be passing RS-232 signals via:
 - OSD menu – in the Misc menu, select Advance>Port Tunneling>Port Settings>Port Type, see [Section 6.5](#).
 - Y commands – select Misc>Advance>Port Tunneling>Port Settings To change these settings see table in [Section 14.2.2](#).
 - **PTN-CFG** protocol 3000 command – see [Section 14.7.4.1](#).

2. Set the HDBT UART via:
 - OSD menu – in the Misc menu, select Advance>Port Tunneling>Port Settings>Port Number, see [Section 6.5](#).
 - Y commands – select Misc>Advance>Port Tunneling>Port Settings To change these settings see table in [Section 14.2.2](#).
 - **UART** protocol 3000 command – see [Section 14.7.4.2](#).

3. Make sure that the **VP-778** is connected to Ethernet.

The **VP-778** is now ready to tunnel RS-232 signals via Ethernet port tunneling.

11 Routing Serial Data

The **VP-778** lets you route serial data through its various ports in the following ways:

- Serial matrix – up to eight sets of connections are created for passing serial data from a selected source to a selected destination.
Select the source/destination ports: port tunnelling, data, HDBT IN1, HDBT IN2 HDBT OUT1, HDBT OUT2 or none (for no connection)
- USR buttons – a programmed command is launched to a selected destination with a press of a USR button (see [Section 8.1.4](#)).
Select the source/destination ports: port tunnelling, data, HDBT IN1, HDBT IN2 HDBT OUT1, HDBT OUT2, all or none (for no connection)

12 Flash Memory Upgrade

This section describes the firmware upgrade of the **VP-778** components that are described in the table below:

File Type	In OSD	Description	Becomes Effective After
RBF	[R]	An *.rbf file to upgrade FPGA	VP-778 application restart
Memory	[M]	upgrades the other Alteras and the OSD bitmap	VP-778 application restart
Application	[A]	The main VP-778 application	VP-778 application restart
Linux kernel	[K]	Includes all drivers for the VP-778 board	Rebooting the board
Cramfs	[C]	A read only Linux file system	Rebooting the board
Bootloader	[B]	Launches the Linux kernel	Rebooting the board
Jffs2	[J]	A read/write file system including the RBF and Memory files, as well as the application	Rebooting the board



The latest firmware version can be downloaded from the Kramer web site at www.kramerav.com/downloads/VP-778

12.1 Firmware Upgrade Process

Unzip the firmware files on your desktop to a folder named “VP-778” and then copy that folder to an empty, FAT32-formated USB memory stick (with at least 30Mb of free space) as a root folder. After copying the “VP-778” folder as a single root folder, the USB memory stick is ready to be used by attaching it into the device.



Make sure that you remove the USB memory stick safely from your PC. Failing to do so may corrupt the firmware files on the memory stick

To upgrade the firmware:

1. Connect the USB memory stick to the S/W UPGRADE USB port on the rear panel of the **VP-778**.

2. On the front panel click the MENU button, select FW Upgrade and then select Upgrade (see [Section 6.5](#)).

The OSD shows the firmware version found in the memory stick:

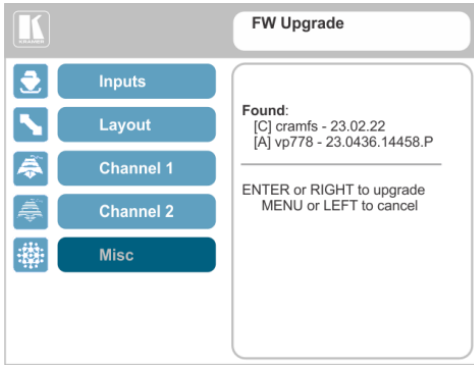

Figure 53: Firmware Upgrade – list of Files to Upgrade

3. Click the ENTER button on the front panel.

Wait for the completion of the upgrade process:

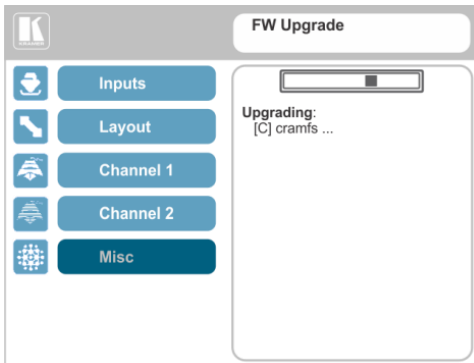

Figure 54: Firmware Upgrade – Upgrade Process

When the firmware upgrade is complete, the list of upgraded files appears:

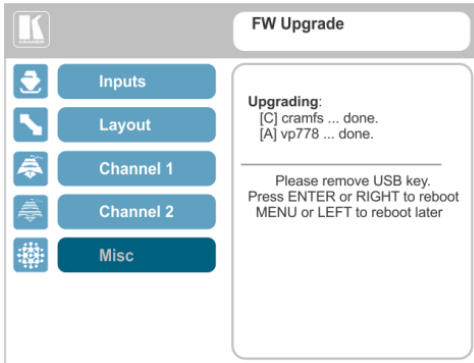

Figure 55: Firmware Upgrade – Upgrade Complete

4. Remove the USB memory stick and click the ENTER button on the front panel to reboot the system.

12.2 Rollback

The Rollback feature lets you restore the previous firmware version installed by the user. To do so:

1. On the front panel click the MENU button, select FW Upgrade and then select Rollback (see [Section 6.5](#)).

The OSD shows the firmware version found in the system:

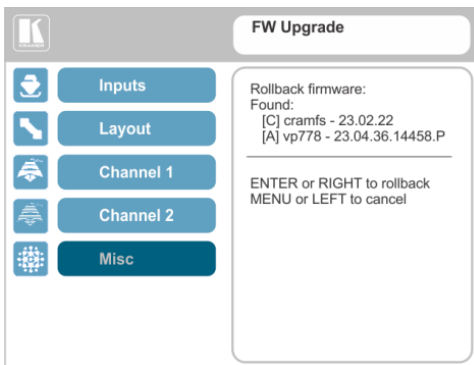

Figure 56: Firmware Upgrade – list of Files to Rollback

2. Press the ENTER button or the left arrow to proceed.
Wait for completion of the procedure.
3. Reboot the machine by turning it off and then on again.

13 Technical Specifications

Inputs:	<p>4 HDMI (deep color) connectors 8 DVI-U (deep color) connectors (DVI, HDMI, PC, YPb Pr, CV) 2 HDBT on RJ-45 connectors 4 HDMI, 2 DVI-U, 2 HDBT on 3.5mm mini jack connectors 2 Mic unbalanced and high impedance on 6mm jack connectors (with selectable 48V phantom power)</p>
Outputs:	<p>2 HDMI (deep color) connectors 2 HDBaseT on an RJ-45 connector 1 S/PDIF digital audio on an RCA connector 1 balanced stereo audio on a 5-pin terminal block connector 1 stereo speaker output, 2x10W into 8Ω, on a 4-pin terminal block connector</p>
Compliance with HDMI Standard:	Supports HDMI and HDCP
Output Resolutions:	<p>640x480@60Hz, 640x480@75Hz, 800x600@50Hz, 800x600@60Hz, 800x600@75Hz, 1024x768@50Hz, 1024x768@60Hz, 1024x768@75Hz, 1280x768@50Hz, 1280x768@60Hz, 1280x800@60Hz, 1280x1024@50Hz, 1280x1024@60Hz, 1280x1024@75Hz, 1360x768@60Hz, 1366x768@50Hz, 1366x768@60Hz, 1400x1050@50Hz, 1400x1050@60Hz, 1600x900@60Hz, 1600x1200@50Hz, 1600x1200@60Hz, 1680x1050@60Hz, 1920x1200@60Hz, 480i@60Hz, 480p@60Hz, 576i@50Hz, 576p@50Hz, 720p@50Hz, 720p@59.94Hz, 720p@60Hz, 1080p@23.976Hz, 1080p@24Hz, 1080p@25Hz, 1080p@29.97Hz, 1080p@30Hz, 1080p@50Hz, 1080p@59.94Hz, 1080p@60Hz, 2048x1080@60Hz, 2048x1080@50Hz, 4K2K@30Hz</p>
Controls:	Front panel buttons, OSD, IR remote control, web pages, 2 RS-232 on terminal block connector, Ethernet, cond/dyn selector switch
Operating Temperature:	0° to +40°C (32° to 104°F)
Storage Temperature:	-40° to +70°C (-40° to 158°F)
Humidity:	10% to 90%, RHL non-condensing
Power Consumption:	100-240V AC, 50VA max.
Dimensions:	19" (W), 9.3" (D) 1U (H) rack mountable
Shipping Dimensions:	52.5cm x 33cm x 10.7cm (20.7" x 13" x 4.2") W, D, H
Weight:	2.6kg (5.7lbs) approx.
Shipping Weight:	3.8kg (8.4lbs) approx.
Included Accessories:	Power cord, rack ears, IR remote control, 2 ADC-DMA/5BF cables. 2 AD-DM/GF adaptors
Specifications are subject to change without notice at www.kramerav.com	

13.1 Default Communication Parameters

RS-232	
Protocol:	3000
Baud Rate:	115,200
Data Bits:	8
Stop Bits:	1
Parity:	None
Command Format:	ASCII
Example (set display mode to Picture-in-Picture):	#Y 0,23,1<CR>
Ethernet	
To reset the IP settings to the factory reset values, power cycle the device while holding in the Ethernet Reset button, located on the rear panel of the unit	
IP Address:	192.168.1.39
Subnet Mask:	255.255.000.000
Default Gateway:	192.168.0.1
TCP Port #:	5000
UDP Port #:	50000
Maximum UDP Ports:	Unlimited
Maximum TCP Ports:	Unlimited
Full Factory Reset	
Front Panel Buttons:	Turn power off. Turn power on again while holding the RESET TO XGA/720p front panel button. The arrow and ENTER buttons flash. Full factory reset is complete once the LEDs cease to flash and react normally. Note that Full Factory reset includes Ethernet reset as well
OSD:	Factory Reset through the Misc menu item (including or excluding ETH)
Web Pages:	Factory reset via the Device Settings embedded web page (including or excluding ETH)
Protocol 3000:	Including ETH: use Factory Reset command "Including ETH" or #Y 0,561,1<CR> Excluding ETH: use Factory Reset command "Excluding ETH" or #Y 0,562,1<CR>

13.2 Input Resolutions

This section defines the input resolutions for each input.

13.2.1 CV Input Resolutions

NTSC and PAL

13.2.2 Component Analog Video (YPbPr) Input Resolutions

PC Input Resolutions			
NTSC	720_P50	1080_P30	1080_P50
PAL	720_P60	1080_P23_976	1080_P60
525_P60	1080_I50	1080_P24	1080_I100
625_P50	1080_I60	1080_P25	

13.2.3 RGBHV Analog Video Input Resolutions

RGBHV Input Resolutions				
640X480_60	800x600_75	625_P50	1280x1024_60	1400x1050_75
640x480_72	800x600_85	525_P60	1280x1024_75	1600x900_60
640x480_75	1024x768_60	720_P50	1280x1024_85	1600x1200_60
640x480_85	1024x768_70	720_P60	1360x768_60	1680x1050_60
800x600_56	1024x768_75	1280x800_60	1366x768_60	1920x1200_60RB
800x600_60	1024x768_85	1280x960_85	1440x900_60	1080_P50
800x600_72	1152x864_75	1280x768_60	1400x1050_60	1080_P60

13.2.4 HDMI Digital Video Input Resolutions

HDMI Input Resolutions				
NTSC	1080_I60	640x480_72	1024x768_70	1360x768_60
PAL	1080_P23_976	640x480_75	1024x768_75	1366x768_60
525_P60	1080_P24	640x480_85	1024x768_85	1440x900_60
625_P50	1080_P25	800x600_56	1152x864_75	1400x1050_60
720_P24	1080_P30	800x600_60	1280x800_60	1400x1050_75
720_P25	1080_P50	800x600_72	1280x960_85	1600x900_60
720_P30	1080_P60	800x600_75	1280x768_60	1600x1200_60
720_P50	2k50	800x600_85	1280x1024_60	1680x1050_60
720_P60	2k60	848x480_60	1280x1024_75	1920x1200_60RB
1080_I50	640X480_60	1024x768_60	1280x1024_85	

13.3 Output Resolutions

This section defines the output resolutions

13.3.1 HDMI Digital Video Output Resolutions

HDMI Output Resolutions			
640x480@60	1280x1024@50	1680x1050@60	1080p30
640x480@75	1280x1024@60	1920x1200@60	1080p50
800x600@50	1280x1024@75	480p60	1080p59.94
800x600@60	1360x768@60	576p50	1080p60
800x600@75	1366x768@50	720p50	1080i50
1024x768@50	1366x768@60	720p59.94	1080i60
1024x768@60	1400x1050@50	720p60	2k50
1024x768@75	1400x1050@60	1080p23.976	2k60
1280x768@50	1600x900@60	1080p24	4k2k@30
1280x768@60	1600x1200@50	1080p25	
1280x800@60	1600x1200@60	1080p29.97	

14 VP-778 RS-232 Communication Protocol

The Kramer Protocol lets you control the **VP-778** from any standard terminal software (for example, the Windows® HyperTerminal Application).

14.1 Using the Communication Protocol

There are three different methods to control the **VP-778** RS-232 or the Ethernet:

- Protocol commands mimicking the OSD, see [Section 14.2](#)
- The button functions mimicking the remote controller buttons (as well as the front panel buttons), see [Section 14.3](#)
- Protocol 3000 common commands, see [Section 14.4](#)



All three tables together include all the protocol commands, but they are not identical and do not always include the same information. Some of the data may appear in one or two of the tables but not in the third table and vice versa.

The protocol 3000 communications protocol uses a data rate of 115200 baud, with no parity, 8 data bits, and 1 stop bit.

14.2 Communication Protocol: Mimicking OSD

The audio/video protocol commands defines all the function numbers, their valid parameters can be used with protocol 3000.

14.2.1 Using the Communication Protocol with Protocol 3000 (the “Y” Command)

Set Command:

Type in: “Y Control_Type=0,Function,Param”

Reply: “~id=01Y Control_Type=0,Function,Param OK”

Set command example: set HDCP mode for input 1 (113) to “On”

Send: “#y 0,113,1”

Result: “~01@Y 0,113,1 OK”

Get Command:

Type in: "Y Control_Type=1,Function"

Result: "~id=01Y Control_Type=1,Function,Param"

Get command example: get HDCP mode for input 3 (113):

Send: "#y 1,113"

Result: "~01@y 1,113,1"

The "Y" command also supports the value increment/decrement of any command using the '+' or '-' signs as the third parameter of the "Y" command.

For example, in order to decrease the volume on the DVI-U2 input (165)

Send: "#Y 0,165,-<CR>"

Reply: "~01@Y 0,165,-OK"

Note that if the value after the decrease is out of range, the reply will show an error such as: "~01@Y ERR -03"

Character Symbols Definitions	
Symbol	Meaning
□	Space
[CR]	Carriage Return, ASCII code 0x0D
[LF] or >	Line Feed, ASCII code 0x0A

14.2.2 Protocol Table: Mimicking OSD

You can associate a function number to its description and valid parameters intuitively by navigating the OSD menu according to the following logic:

A function number is directly related to its location in the OSD menu.

For example, the second menu on the OSD is Layout (2 in the hundreds). The third menu item in Layout is Overlay Settings (2 in the tens), therefore the function number for it will be 230 (2nd item on the Main menu and the 3rd item in the Layout submenu (see also [Section 6.1](#)). When navigating in the OSD MENU you will be able to see the Overlay Settings valid parameters.



Note that for the Inputs, menu levels 3, 4 and 5 are valid for each input from 1 to 8. For example, Type (3rd level) item is 111 for Input 1 and 121 for Input 2, and so on. In order not to repeat the Inputs menu for each input, the function list will have an x denoting the input number from 1 to 8. For example, the Type item will have 1x1 as the function number x being from 1 to 8.

The following table shows the Program function numbering.



Note that some items that appear in red on the OSD menu seem missing in the table below. These items will be enabled in future firmware and will be described in detail.

The following table defines the protocol commands:

14.2.2.1 Inputs Commands Table (1st Level)

2 nd Level	3 rd Level	4 th Level	5 th Level	Range	Func.	Notes	
HDMI 1 HDMI 2 HDMI 3 HDMI 4 DVI-U1 DVI-U2 HDBT1 HDBT2	Type	HDMI (default)		0	1x1		
		YUV		1		DVI input only	
		VGA		2		DVI input only	
		CV		3		DVI input only	
	EDID Management	Native Resolution	1024x768 @60	1024x768 @60	0	1x21	
			1280x800 @60	1280x800 @60	1		
			1280x1024 @60	1280x1024 @60	2		
			1366x768 @60	1366x768 @60	3		
			1440x900 @60	1440x900 @60	4		
			1400x1050 @60	1400x1050 @60	5		
			1600x900 @60	1600x900 @60	6		
			1600x1200 @60	1600x1200 @60	7		
			1680x1050 @60	1680x1050 @60	8		
			1920x1200 @60RB	1920x1200 @60RB	9		
			720p50	720p50	10		
			720p60	720p60	11		
			1080p50	1080p50	12		
			1080p60 (default)	1080p60 (default)	13		
			2k50	2k50	14		
	2k60	2k60	15				
	Color Depth		12 BPP	12 BPP	0	1x22	
			8 BPP	8 BPP	1		
	Modeline		Multiple Modeline	Multiple Modeline	0	1x23	
			Single Modeline	Single Modeline	1		
	Audio Channels		5.1	5.1	0	1x24	
			Stereo	Stereo	1		
	HDCP Mode		Off	Off	0	1x3	
On			On	1			
Color Space		RGB	RGB		1x4		
		YPbPr	YPbPr				
		Follow Input	Follow Input				
Volume		<progress bar>		[-80:+20]	1x5		

14.2.2.2 Layout Commands Table (1st Level)

2 nd Level	3 rd Level	4 th Level	Range	Func.	Notes
Display Mode	Transition		0	21	
	Overlay		1		
Transition settings	Speed	<progress bar>	[1:15]	221	Transition Mode only
	Mode	Swap	0	222	
		Follow	1		
	Effect	Cut	0	223	
		Fade	1		
	Directions	N/A			
Take	<action>		-	225	
Overlay Settings	Single Window		0	23	
	Picture in Picture		1		
	Picture + Picture		2		
	Split		3		
	Customize Single		4		
	Customize Dual		5		
Output	Video Resolution	NATIVE	0	241	
		640x480p60	1		
		640x480p75	2		
		800x600p50	3		
		800x600p50	4		
		800x600p75	5		
		1024x768p50	6		
		1024x768p60	7		
		1024x768p75	8		
		1280x768p50	9		
		1280x768p60	10		
		1280x800p60	11		
		1280x1024p50	12		
		1280x1024p60	13		
		1280x1024p75	14		
		1360x768p60	15		
		1366x768p50	16		
		1366x768p60	17		
		1400x1050p50	18		
		1400x1050p60	19		
		1600x900p60	20		
		1600x1200p50	21		
		1600x1200p60	22		
		1680x1050p60	23		
		1920x1200p60RB	24		
		480p60	25		
		576p50	26		
		720p50	27		
		720p59_94	28		
		720p60	29		
		1080p23_976	30		
1080p24	31				

2 nd Level	3 rd Level	4 th Level	Range	Func.	Notes		
		1080p25	32				
		1080p29_97	33				
		1080p30	34				
		1080p50	35				
		1080p59_94	36				
		1080p60	37				
		1080i50	38				
		1080i60	39				
		2k50	40				
		2k60	41				
		4k2k30	42				
		Master Connection	HDMI1		0	242	
			HDBT1		1		
	HDMI2		2				
	HDBT2		3				
	Deep Color	Off	0	243			
		Follow Output	1				
	Color Space	RGB	0	244			
		YPbPr422	1				
		YPbPr444	2				
	HDCP Mode	Follow Output	0	245			
		Follow Input	1				

14.2.2.3 Channel 1 and Channel 2 Commands Table (1st Level)

2 nd Level	3 rd Level	4 th Level	5 th Level	6 th Level	Range	Func. CH1/CH2	
Input	HDMI1				0	31/41	
	HDMI2				1		
	HDMI3				2		
	HDMI4				3		
	DVI-U1				4		
	DVI-U2				5		
	HDBT1				6		
	HDBT2				7		
Scaling	Aspect Ratio	Follow Input			0	321/421	
		Follow Output			1		
		Best Fit			2		
		Letterbox			3		
	Overscan	Follow Input				0	322/422
		Off				1	
		5%				2	
		10%				3	
	Zoom Shift Mode	Auto				0	323/423
		Semi Auto				1	
Customized					2		
Zoom	<progress bar>				[8:4000]	324/424	
H Image Shift	<progress bar>				[20:790]	325/425	
V Image Shift	<progress bar>				[4:239]	326/426	
Window Customization	H position	<progress bar>			[0:2046]	331/431	
	Width	<progress bar>			[16:3840]	332/432	
	V position	<progress bar>			[0:2046]	333/433	
	Height	<progress bar>			[9:2160]	3334/4334	
	1. Ineffective in transition mode. 2. In overlay single window will trigger Customize Single. 3. In overlay Dual window (pip p+p...) will trigger Customize Dual.						
Picture	Brightness	<progress bar>			[-512:512]	341/441	
	Contrast	<progress bar>			[10:160]	342/442	
	H Sharpness	<progress bar>			[-10:10]	343/443	
	V Sharpness	<progress bar>			[-10:10]	344/444	
Color	Chroma	<progress bar>			[0:400]	351/451	
	Hue	<progress bar>			[-180:180]	352/452	
	Color Temperature	6500K				0	353/453
		9300K				1	
	Gamma Mode	Gamma Off				0	354/454
		Gamma 0.4				1	
		Gamma 0.8				2	
		Gamma 1.2				3	
		Gamma 1.6				4	
		Gamma 2.0				5	
Gamma 2.4					6		
Gamma 2.8				7			
Color Correction Blue	<progress bar>				[0:4]	355/455	
Color Correction Green	<progress bar>				[0:4]	356/456	

2 nd Level	3 rd Level	4 th Level	5 th Level	6 th Level	Range	Func. CH1/CH2		
	Color Correction Red	<progress bar>			[0:4]	357/457		
De-interlacing	Film Mode	Off			0	361/461		
		Follow Input			1			
		24PsF Mode			2			
	PD time	<progress bar>			[0:15]	362/462		
	Motion Detection Sensitivity	LEVEL1				0	363/463	
		LEVEL2				1		
		LEVEL3				2		
LEVEL4					3			
LEVEL5					4			
Diagonal Correction	<progress bar>				[0:3]	364/464		
Noise Reduction	Horizontal NR	<progress bar>				[0:3]	371/471	
	Vertical NR	<progress bar>				[0:3]	372/472	
	Temporal NR	<progress bar>				[0:3]	373/473	
	Block NR	<progress bar>				[0:3]	374/474	
	Mosquito NR	<progress bar>				[0:3]	375/475	
	Combing NR	<progress bar>				[0:3]	376/476	
Advance	Projection	Front				1	381/481	
		Back				2		
		Ceiling Front				3		
		Ceiling Back				4		
	Pause	Freeze	Off				0	3821/4821
			On				1	
		Blank	Off				0	3822/4822
			On				1	
	Mute	Off				0	3823/4823	
		On				1		
	Sync Off	Auto	Enable	Off			0	38311/ 48311
				On			1	
			Timeout	<progress bar>			[0:5]	38312/ 48312
		Manual	<countdown action>			-	3832/4832	
	Test Pattern	Off					0	384/484
		Slide Bar					1	
		Color Bar					2	
	No Signal	Gray					0	385/485
		Blue					1	
		Black					2	
Fade-Thru	Black					0	386/486	
	Freeze					1		
Auto Switching	Mode	Off				0	3871/4871	
		Scan Mode				1		
		Last Connected				2		
	Priority		see Priority Commands table below					

2 nd Level	3 rd Level	4 th Level	5 th Level	6 th Level	Range	Func. CH1/CH2	
Audio	Source	AFV			0	391/491	
		Analog 1			1		
		Analog 2			2		
		Analog 3			3		
		Analog 4			4		
		Analog 5			5		
		Analog 6			6		
		Analog 7			7		
	AFV Mode	Embedded			0	392/492	
		Analog			1		
	Proc Amp	Output Volume	<progress bar>			[-80:20]	3931/4931
		Bass	<progress bar>			[-18,18]	3932/4932
		Mid	<progress bar>			[-18,18]	3933/4933
		Treble	<progress bar>			[-10:10]	3934/4934
		Balance	<progress bar>			[-10:10]	3935/4935
	Lip Sync	<progress bar>				[0:170]	394/494
	Pass-Through	Off				0	395/495
		On				1	
	Mic Effect		See Audio Mic Effect table below				

Priority commands

4th Level	5th Level	6th Level	7th Level	Range	Func. CH1/CH2
Priority	1-8	Input	HDMI1	0	3872x1/4872x1
			HDMI2	1	
			HDMI3	2	
			HDMI4	3	
			DVI-U1	4	
			DVI-U2	5	
			HDBT1	6	
			HDBT2	7	
		Active	Off	0	3872x2/4872x2
			On	1	

The Audio MIC Effect applies only to Channel 1 (1st Level)

2 nd Level	3 rd Level	4 th Level	5 th Level	6 th Level	Range	Func. MIC1/MIC2
Audio	Mic1 / Mic 2	Mic Mode	Talkover		0	39611/39711
			Mix		1	
		Talkover Settings	Talkover Depth	<progress bar>	[30:100]	396121/397121
			Talkover Trigger	<progress bar>	[-90:33]	396122/397122
			Attack Time	<progress bar>	[1:12]	396123/397123
			Hold Time	<progress bar>	[0:2000]	396124/397124
			Release Time	<progress bar>	[0:100]	396125/397125
		Mic Mix	<progress bar>		[-30:6]	39623/39723
		Mic Volume	<progress bar>		[-16:16]	39624/39724
		Mic Delay	<progress bar>		[1:40]	39625/39725
	Mic Mute	Off		0	39626/39726	
		ON		1		
	Line Mix	<progress bar>		[-30:6]	39627/39727	
	Line Mute	Off		0	3963/	
On			1			

14.2.2.4 Misc Commands Table

2 st Level	3 st Level	4 st Level	5 st Level	6 st Level	Range	Func.
Information	Channel 1	<info screen>			-	511
	Channel 2	<info screen>			-	512
	FW Version	<info screen>			-	513
	Network	<info screen>			-	514
	HDBT	HDBT-IN1 / HDBT-IN2 / HDBT-OUT1 / HDBT-OUT2	Firmware Status	<info screen> <info screen>	0 1	515x1 515x2
OSD	H Position	<progress bar>			[0:2047]	521
	V Position	<progress bar>			[0:2047]	522
	Transparency	Off			0	523
		On			1	
	Gain	<progress bar>			[1:4]	524
	Bias	<progress bar>			[-128:127]	525
	Timeout	Off			0	526
30 Sec				1		
60 Sec				2		
Keying	Chroma Keying Red	<progress bar>			[0:240]	531
	Chroma Keying Green	<progress bar>			[0:240]	532
	Chroma Keying Blue	<progress bar>			[0:240]	533
	Chroma Keying	Off			0	534
		On			1	
	Luma Keying	Off			0	535
On				1		
FW Upgrade	Upgrade	<action screen>			-	541
	Rollback	<action screen>			-	542

2st Level	3st Level	4st Level	5st Level	6st Level	Range	Func.	
Advance	Alert System	N/A				551	
	Port Tunneling	Port Settings	Port Type	UDP	0	55211	
				TCP	1		
			Port Number	<progress bar>	[0:64000]	55212	
		UART Setting	Baudrate	1200	0	55221	
				2400	1		
				4800	2		
				9600	3		
				19200	4		
				92400	5		
				57600	6		
				115200	7		
				Data Bits	5	0	55222
					6	1	
					7	2	
					8	3	
				Parity	None	0	55223
					Odd	1	
	Even	2					
	Mark	3					
	Stop Bits	1	0	55224			
		2	1				
	Serial Matrix	Connection 1 \ Connection 2 \ Connection 3 \ Connection 4 \ Connection 5 \ Connection 6 \ Connection 7 \ Connection 8	Source \ Destination	Port Tunneling	0	553x1 (source) 553x2 (destination)	
				DATA	1		
				HDBT-IN1	2		
				HDBT-IN2	3		
				HDBT-OUT1	4		
				HDBT-OUT2	5		
				None	6		
				Disconnect All	<action screen>		
	Power Amplifier	Off			0	554	
		Power Level 1			1		
		Power Level 2			2		
		Power Level 3			3		
		Power Level 4			4		
	USR KeyPad	USR1 / USR2	Baudrate	1200	0	555x1	
				2400	1		
				4800	2		
				9600	3		
				19200	4		
				92400	5		
				57600	6		
				115200	7		
			Data Bits	5	0	555x2	
				6	1		
	7	2					
	8	3					

2st Level	3st Level	4st Level	5st Level	6st Level	Range	Func.
			Parity	None	0	555x3
				Odd	1	
				Even	2	
				Mark	3	
				Space	4	
			Stop Bits	1	0	555x4
				2	1	
			Destination	Port Tunneling	0	555x5
				DATA	1	
				HDBT-IN1	2	
	HDBT-IN2	3				
	HDBT-OUT1	4				
	HDBT-OUT2	5				
	All	6				
None	7					
Data Display	<action screen>	-	555x6			
Launch	<action screen>	-	555x7			
Factory Reset	Including ETH	<action screen>	-	561		
	Excluding ETH	<action screen>	-	562		

14.3 Protocol Table: Mimicking Remote and Front Panel Buttons

The keystroke codes operate in the following way:

SET command third param =0,

Syntax example: "#Y 0,920,0<CR>" => MENU keystroke

GET command for keystrokes will return ERR

The following table defines the keystroke function codes:

Button	Keystroke Code	Button	Keystroke Code	Button	Keystroke Code
KEYCODE MENU	920	KEYCODE PREV FREEZE	932	KEYCODE PREV IN2	944
KEYCODE ENTER	921	KEYCODE PROG BLANK	933	KEYCODE PREV IN3	945
KEYCODE DOWN	922	KEYCODE PROG FREEZE	934	KEYCODE PREV IN4	946
KEYCODE UP	923	KEYCODE PROG IN1	935	KEYCODE PREV IN5	947
KEYCODE LEFT	924	KEYCODE PROG IN2	936	KEYCODE PREV IN6	948
KEYCODE RIGHT	925	KEYCODE PROG IN3	937	KEYCODE PREV IN7	949
KEYCODE RESET	926	KEYCODE PROG IN4	938	KEYCODE PREV IN8	950
KEYCODE LOCK	927	KEYCODE PROG IN5	939	KEYCODE PROG MUTE	951
USR1	928	KEYCODE PROG IN6	940	KEYCODE PREV MUTE	952
USR2	929	KEYCODE PROG IN7	941	KEYCODE POWER	953
KEYCODE MODE	930	KEYCODE PROG IN8	942		
KEYCODE PREV BLANK	931	KEYCODE PREV IN1	943		

14.4 Protocol 3000 Common Operation Commands

The **VP-778** can be operated using the Kramer Protocol 3000 serial commands.

The command framing varies according to how you interface with the **VP-778**. For example, a basic video input switching command that routes a layer 1 video signal to HDMI out 1 from HDMI input 2 (`ROUTE 1,1,2`), is entered as follows:

- Terminal communication software, such as Hercules:

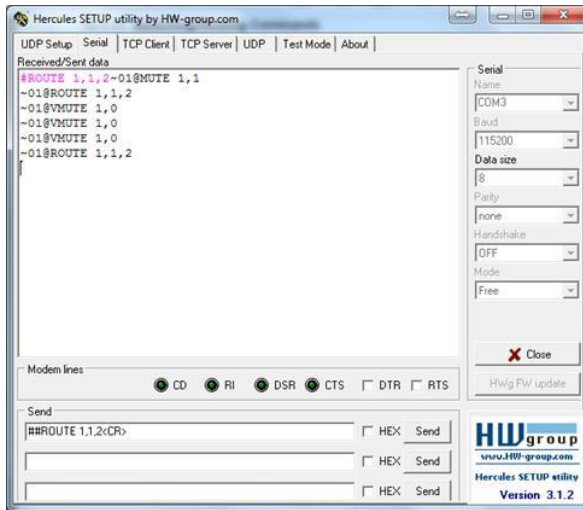

The framing of the command varies according to the terminal communication software.

- K-Touch Builder (Kramer software):

'Device Code (17)' PROPERTIES	
name	Device Code (17)
data	#ROUTE 1,1,2w0D

- K-Config (Kramer configuration software):

```
"#ROUTE 1,1,2",0x0D
```

Set

Clear



All the examples provided in this section are based on using the K-Config software.

You can enter commands directly using terminal communication software (e.g., Hercules) by connecting a PC to the serial or Ethernet port on the **VP-778**. To enter `CR` press the Enter key (`LF` is also sent but is ignored by the command parser).

Commands sent from various non-Kramer controllers (e.g., Crestron) may require special coding for some characters (such as, `/x##`). For more information, refer to your controller's documentation.

For more information about:

- Using Protocol 3000 commands, see [Section 14.5](#)
- General syntax used for Protocol 3000 commands, see [Section 14.6](#)
- Protocol 3000 commands available for the **VP-778**, see [Section 14.7](#)

14.5 Understanding Protocol 3000

Protocol 3000 commands are structured according to the following:

- **Command** – A sequence of ASCII letters (A-Z, a-z and -). A command and its parameters must be separated by at least one space.
- **Parameters** – A sequence of alphanumeric ASCII characters (0-9, A-Z, a-z and some special characters for specific commands). Parameters are separated by commas.
- **Message string** – Every command entered as part of a message string begins with a message starting character and ends with a message closing character.



A string can contain more than one command. Commands are separated by a pipe (|) character.

The maximum string length is 64 characters.

- **Message starting character:**
 - # – For host command/query
 - ~ – For device response
- **Device address** – K-NET Device ID followed by @ (optional, K-NET only)
- **Query sign** – ? follows some commands to define a query request
- **Message closing character:**
 - CR – Carriage return for host messages (ASCII 13)
 - CR LF – Carriage return for device messages (ASCII 13) and line-feed (ASCII 10)
- **Command chain separator character** – Multiple commands can be chained in the same string. Each command is delimited by a pipe character (|). When chaining commands, enter the message starting character and the message closing character only at the beginning and end of the string.



Spaces between parameters or command terms are ignored. Commands in the string do not execute until the closing character is entered. A separate response is sent for every command in the chain.

14.6 Kramer Protocol 3000 Syntax

The Kramer Protocol 3000 syntax uses the following delimiters:

- **CR** = Carriage return (ASCII 13 = 0x0D)
- **LF** = Line feed (ASCII 10 = 0x0A)
- **SP** = Space (ASCII 32 = 0x20)

Some commands have short name syntax in addition to long name syntax to enable faster typing. The response is always in long syntax.

The Protocol 3000 syntax is in the following format:

- Host Message Format:

Start	Address (optional)	Body	Delimiter
#	Device_id@	Message	CR

- **Simple Command** – Command string with only one command without addressing:

Start	Body	Delimiter
#	Command SP Parameter_1,Parameter_2,...	CR

- **Command String** – Formal syntax with command concatenation and addressing:

Start	Address	Body	Delimiter
#	Device_id@	Command_1 Parameter1_1,Parameter1_2,... Command_2 Parameter2_1,Parameter2_2,... Command_3 Parameter3_1,Parameter3_2,...	CR

- Device Message Format:

Start	Address (optional)	Body	Delimiter
~	Device_id@	Message	CR LF

- Device Long Response – Echoing command:

Start	Address (optional)	Body	Delimiter
~	Device_id@	Command SP [Param1 ,Param2 ...] [result]	CR LF

14.7 Protocol 3000 Commands

This section includes the following commands:

- System commands (see [Section 14.7.1](#))
- Communication commands (see [Section 14.7.2](#))
- Route commands (see [Section 14.7.3](#))
- Device-specific commands (see [Section 14.7.4](#))
- Audio commands (see [Section 14.7.4.2](#))
- Video commands (see [Section 14.7.6](#))

14.7.1 System Commands

Command	Description
#	Protocol handshaking
BUILD-DATE	Get device build date (system mandatory)
FACTORY	Reset to factory default configuration
MODEL	Get device model (system mandatory)
PROT-VER	Get device protocol version (system mandatory)
RESET	Reset device (system mandatory)
SN	Get device serial number (system mandatory)
VERSION	Get device firmware version (system mandatory)
NAME	Set machine (DNS) name
LOCK-FP	Set/get front panel lock
NAME-RST	Reset machine (DNS) name to factory default
TIME	Device time and date
POWER	Set/get power mode

14.7.1.1

Functions	Permission	Transparency
Set: #	End User	Public
Get: -	-	-
Description	Syntax	
Set: Protocol handshaking	# <code>CR</code>	
Get: -	-	
Response		
~ <code>nn@SE</code> OK <code>CR LF</code>		
Notes		
Validates the Protocol 3000 connection and gets the machine number Step-in master products use this command to identify the availability of a device		
K-Config Example		
`#", 0x0D		

14.7.1.2 BUILD-DATE

Functions		Permission	Transparency
Set:	-	-	-
Get:	BUILD-DATE?	End User	Public
Description		Syntax	
Set:	-	-	
Get:	Get device build date	# BUILD-DATE? <input type="checkbox"/>	
Response			
~nn@ BUILD-DATE? <input type="checkbox"/> dateSEtimeCR LF			
Parameters			
date – Format: YYYY/MM/DD where YYYY = Year, MM = Month, DD = Day			
time – Format: hh:mm:ss where hh = hours, mm = minutes, ss = seconds			
K-Config Example			
`#BUILD-DATE?`,0x0D			

14.7.1.3 FACTORY

Functions		Permission	Transparency
Set:	FACTORY	End User	Public
Get:	-	-	-
Description		Syntax	
Set:	Reset device to factory default configuration	# FACTORY? <input type="checkbox"/>	
Get:	-	-	
Response			
~nn@ FACTORY? <input type="checkbox"/> OKCR LF			
Notes			
This command deletes all user data from the device. The deletion can take some time. Your device may require powering off and powering on for the changes to take effect.			
K-Config Example			
`#FACTORY`,0x0D			

14.7.1.4 MODEL

Functions		Permission	Transparency
Set:	-	-	-
Get:	MODEL?	End User	Public
Description		Syntax	
Set:	-	-	
Get:	Get device model	# MODEL? <code>[CR]</code>	
Response			
~ <code>[nn]</code> @ MODEL? <code>[SE]</code> <i>model_name</i> <code>[CR LF]</code>			
Parameters			
<i>model_name</i> – String of up to 19 printable ASCII chars			
Notes			
This command identifies equipment connected to Step-in master products and notifies of identity changes to the connected equipment. The Matrix saves this data in memory to answer REMOTE-INFO requests			
K-Config Example			
"#MODEL?",0x0D			

14.7.1.5 PROT-VER

Functions		Permission	Transparency
Set:	-	-	-
Get:	PROT-VER?	End User	Public
Description		Syntax	
Set:	-	-	
Get:	Get device protocol version	# PROT-VER? <code>[CR]</code>	
Response			
~ <code>[nn]</code> @ PROT-VER? <code>[SE]</code> 3000: <i>version</i> <code>[CR LF]</code>			
Parameters			
<i>version</i> - XX.XX where X is a decimal digit			
K-Config Example			
"#PROT-VER?",0x0D			

14.7.1.6 RESET

Functions		Permission	Transparency
Set:	RESET	Administrator	Public
Get:	-	-	-
Description		Syntax	
Set:	Reset device	# RESET <code>CR</code>	
Get:	-	-	
Response			
~ <code>nn</code> @ RESET <code>SE</code> <code>OK</code> <code>CR LF</code>			
Notes			
To avoid locking the port due to a USB bug in Windows, disconnect USB connections immediately after running this command. If the port was locked, disconnect and reconnect the cable to reopen the port.			
K-Config Example			
`"#RESET",0x0D			

14.7.1.7 SN

Functions		Permission	Transparency
Set:	-	-	-
Get:	SN?	End User	Public
Description		Syntax	
Set:	-	-	
Get:	Get device serial number	# SN? <code>CR</code>	
Response			
~ <code>nn</code> @ SNSE <code>serial_number</code> <code>CR LF</code>			
Parameters			
<i>serial_number</i> – 14 decimal digits, factory assigned			
Notes			
This device has a 14 digit serial number that are displayed			
K-Config Example			
`"#SN?",0x0D			

14.7.1.8 VERSION

Functions		Permission	Transparency
Set:	-	-	-
Get:	VERSION?	End User	Public
Description		Syntax	
Set:	-	-	
Get:	Get firmware version number	#VERSION? CR	
Response			
~nn@VERSION SP firmware_version CR LF			
Parameters			
firmware_version - XX.XX.XXX.XXXXX.XX where the digit groups are: major.minor.build version.FW version.board HW version			
Notes			
Digit groups are defined as follows:			
<p style="text-align: center;"> Major Version Minor Version Build Version FW Version Board HW Version </p> <p style="text-align: center;"> Compilation Type Build Version FW Version Board HW Version </p>			
K-Config Example			
"#VERSION?", 0x0D			

14.7.1.9 NAME

Functions		Permission	Transparency
Set:	NAME	Administrator	Public
Get:	NAME?	End User	Public
Description		Syntax	
Set:	Set machine (DNS) name	#NAME SP machine_name CR	
Get:	Get machine (DNS) name	#NAME? CR	
Response			
Set: ~nn@NAME SP machine_name SP OK CR LF			
Get: ~nn@NAME? SP machine_name CR LF			
Parameters			
machine_name - String of up to 14 alpha-numeric characters (can include hyphens but not at the beginning or end)			
Notes			
The machine name is not the same as the model name. The machine name is used to identify a specific machine or a network in use (with DNS feature on).			
K-Config Example			
Set the DNS name of the device to "room-442": "#NAME room-442", 0x0D			

14.7.1.1 LOCK-FP

Functions		Permission	Transparency
Set:	LOCK-FP	End User	Public
Get	LOCK-FP?	End User	Public
Description		Syntax	
Set:	Lock the port	# LOCK-FP SP <i>lock_mode</i> CR	
Get:	Get the port lock state	# LOCK-FP?	
Response			
~ nn @ LOCK-FP SP <i>lock_mode</i> SP OK CR LF			
Parameters			
<i>lock_mode</i> – Front panel locking state: unlock front panel buttons=0, lock front panel buttons=1			
K-Config Example			
Unlock port: "#LOCK-FP 0",0x0D			

14.7.1.2 NAME-RST

Functions		Permission	Transparency
Set:	NAME-RST	Administrator	Public
Get			
Description		Syntax	
Set:	Reset machine (DNS) name to factory default	# NAME-RST CR	
Get:	-	-	
Response			
~ nn @ NAME-RST SP OK CR LF			
Notes			
Factory default of machine (DNS) name is "VP-778-" + 4 last digits of device serial number			
K-Config Example			
Get the input signal lock status of HDMI In: "#NAME-RST",0x0D			

14.7.1.3 TIME

Functions		Permission	Transparency
Set:	TIME	-	-
Get	TIME?	End User	Public
Description		Syntax	
Set:	Set device time and date	# TIME [SE]day_of_week,date,time[CR]	
Get:	Get device time and date	# TIME? [CR]	
Response			
~nn@ TIME [SE]day_of_week,date,time[SE]OK[CR LF]			
Parameters			
<i>Day_of_week</i> – select one of {SUN, MON, TUE, WED, THU, FRI, SAT} <i>date</i> – set DD-MM-YYYY <i>time</i> – set: hh:mm:ss			
Notes			
The year must be 4 digits; The device does not validate the day of week from the date Time format - 24 hours; Date format - Day, Month, Year			
K- Config Example			
Set the date and time: "#TIME Tue,25-04-2017,16:30:00",0x0D			

14.7.1.4 POWER-MODE

Functions		Permission	Transparency
Set:	POWER	End User	Public
Get:	POWER?	End User	Audio
Description		Syntax	
Set:	Set power mode	# POWER-MODE [SE]power-mode[CR]	
Get:	Get power mode status	# POWER-MODE? [CR]	
Response			
~nn@ POWER [SE]power_mode[SE]OK[CR LF]			
Parameters			
<i>Power_mode</i> – power state: Power Off=0 (Off, enter standby mode), power On=1 (On)			
K-Config Example			
Set power to Off "#power 0",0x0D			

14.7.2 Communication Commands

Command	Description
ETH-PORT	Set/get Ethernet port protocol
NET-DHCP	Set/get DHCP mode
NET-GATE	Set/get gateway IP
NET-IP	Set/get IP address
NET-MAC	Get MAC address
NET-MASK	Set/get subnet mask

14.7.2.1 ETH-PORT

Functions		Permission	Transparency
Set:	ETH-PORT	Administrator	Public
Get:	ETH-PORT?	End User	Public
Description		Syntax	
Set:	Set Ethernet port protocol	# ETH-PORT SP <i>portType</i> , <i>ETHPort</i> CR	
Get:	Get Ethernet port protocol	# ETH-PORT? SP <i>portType</i> CR	
Response			
~ nn @ ETH-PORT SP <i>portType</i> , <i>ETHPort</i> SP OK CR LF			
Parameters			
<i>portType</i> – string of 3 letters indicating the port type: TCP, UDP			
<i>ETHPort</i> – TCP / UDP port number=1-65535, 0=reset port to factory default (50000 for UDP, 5000 for TCP)			
Notes			
If the port number you enter is already in use, an error is returned			
K-Config Example			
Set the Ethernet port protocol for TCP to port 12457: "#ETH-PORT TCP,12457",0x0D			

14.7.2.2 NET-DHCP

Functions		Permission	Transparency
Set:	NET-DHCP	Administrator	Public
Get:	NET-DHCP?	End User	Public
Description		Syntax	
Set:	Set DHCP mode	#NET-DHCP <input type="checkbox"/> mode <input type="checkbox"/>	
Get:	Get DHCP mode	#NET-DHCP? <input type="checkbox"/>	
Response			
~nn@NET-DHCP <input type="checkbox"/> mode <input type="checkbox"/> OK <input type="checkbox"/> CR LF			
Parameters			
<i>mode</i> – 0 (do not use DHCP. Use the IP address set by the factory or the NET-IP command), 1 (try to use DHCP. If unavailable, use the IP address set by the factory or the NET-IP command), 2 (try to use DHCP, if unavailable use AUTO-IP)			
Notes			
Connecting Ethernet to devices with DHCP may take more time in some networks To connect with a randomly assigned IP by DHCP, specify the device DNS name (if available) using the NAME command. You can also get an assigned IP by direct connection to USB or RS-232 protocol port if available Consult your network administrator for correct settings			
K-Config Example			
Enable DHCP mode, if available: "#NET-DHCP 1",0x0D			

14.7.2.3 NET-GATE

Functions		Permission	Transparency
Set:	NET-GATE	Administrator	Public
Get:	NET-GATE?	End User	Public
Description		Syntax	
Set:	Set gateway IP	#NET-GATE <input type="checkbox"/> ip_address <input type="checkbox"/>	
Get:	Get gateway IP	#NET-GATE? <input type="checkbox"/>	
Response			
~nn@NET-GATE <input type="checkbox"/> ip_address <input type="checkbox"/> OK <input type="checkbox"/> CR LF			
Parameters			
<i>ip_address</i> – gateway IP address, in the following format: xxx.xxx.xxx.xxx			
Notes			
A network gateway connects the device via another network, possibly over the Internet. Be careful of security problems. Consult your network administrator for correct settings.			
K-Config Example			
Set the gateway IP address to 192.168.0.1: "#NET-GATE 192.168.000.001",0x0D			

14.7.2.4 NET-IP

Functions		Permission	Transparency
Set:	NET-IP	Administrator	Public
Get:	NET-IP?	End User	Public
Description		Syntax	
Set:	Set IP address	# NET-IP SE <i>ip_address</i> CR	
Get:	Get IP address	# NET-IP? CR	
Response			
~nn@ NET-IP SP <i>ip_address</i> SE OK CR LF			
Parameters			
<i>ip_address</i> – IP address, in the following format: xxx.xxx.xxx.xxx			
Notes			
Consult your network administrator for correct settings			
K-Config Example			
Set the IP address to 192.168.1.39: "#NET-IP 192.168.001.039",0x0D			

14.7.2.5 NET-MAC

Functions		Permission	Transparency
Set:	-	-	-
Get:	NET-MAC?	End User	Public
Description		Syntax	
Set:	-	-	
Get:	Get MAC address	# NET-MAC? CR	
Response			
~nn@ NET-MAC SE <i>mac_address</i> CR LF			
Parameters			
<i>mac_address</i> – unique MAC address. Format: XX-XX-XX-XX-XX-XX where X is hex digit			
K-Config Example			
"#NET-MAC?",0x0D			

14.7.2.6 NET-MASK

Functions		Permission	Transparency
Set:	NET-MASK	Administrator	Public
Get:	NET-MASK?	End User	Public
Description		Syntax	
Set:	Set subnet mask	# NET-MASK [SP] <i>net_mask</i> [CR]	
Get:	Get subnet mask	# NET-MASK? [CR]	
Response			
~nn@ NET-MASK [SP] <i>net_mask</i> [SP]OK[CR LF]			
Parameters			
<i>net_mask</i> - format: xxx.xxx.xxx.xxx			
Response Triggers			
The subnet mask limits the Ethernet connection within the local network Consult your network administrator for correct settings			
K-Config Example			
Set the subnet mask to 255.255.0.0: `#NET-MASK 255.255.000.000`,0x0D			

14.7.3 Route Commands

Command	Description
ROUTE	Set/get layer routing

14.7.3.1 ROUTE

Functions		Permission	Transparency
Set:	ROUTE	End User	Public
Get:	ROUTE	End User	Public
Description		Syntax	
Set:	Set layer routing	# ROUTE [SP] <i>layer,dest,src</i> [CR]	
Get:	Get layer routing	# ROUTE? [SP] <i>layer,dest</i> [CR]	
Response			
~nn@ ROUTE [SP] <i>layer,dest,src</i> [SP]OK[CR LF]			
Parameters			
<i>layer</i> - Input to route: video=1, audio=2, AFV=12 <i>dest</i> - Scaler: Channel 1=0, Channel 2=1 <i>src</i> - Input numbers: HDMI 1=0, HDMI 2=1, HDMI 3=2, HDMI 4=3, DVI-U1=4, DVI-U2=5, HDBT 1=6, HDBT 2=7			
K-Config Example			
Route Video to channel 1 from HDMI 4: `#ROUTE 1,0,3`,0x0D			

14.7.4 Device-Specific Commands

Command	Description
PTNL-CFG	Set/get port tunneling configuration
UART	Set/get port tunneling com port configuration
CBIN	Configure USR Keypad communication parameters
DBIN	Program USR Keypad command
BIN	Launch USR Keypad command

14.7.4.1 PTNL-CFG

Functions		Permission	Transparency
Set:	PTNL-CFG	End User	-
Get:	PTNL-CFG?	End User	Public
Description		Syntax	
Set:	Set port tunneling Ethernet configuration	# PTNL-CFG [SE] P0 , P1 [CR]	
Get:	Get port tunneling Ethernet configuration	# PTNL-CFG? [SE]	
Response			
~ [nn] @ PTNL-CFG [SE] P0 , P1 [SE] OK [CR LF]			
Parameters			
P0 – Port type: UDP, TCP P1 – Port number: 1-64000			
K-Config Example			
Set port type to UDP to port 5050: "#PTNL-CFG UDP,5050,on",0x0D			

14.7.4.2 UART

Functions		Permission	Transparency
Set:	UART	Administrator	Public
Get:	UART?	End User	Public
Description		Syntax	
Set:	Set port tunneling UART configuration	# UART [SE] baud_rate , data_bits , parity , stop_bits [CR]	
Get:	Get port tunneling UART configuration	# UART? [SE]	
Response			
~ [nn] @ UART [SE] baud_rate , data_bits , parity , stop_bits [SE] OK [CR LF]			
Parameters			
baud_rate – 1200, 2400, 4800, 9600, 19200, 38400, 57600, 115200 data_bits – 5 to 8 data bits parity – none, odd, even, mark, space, n, o, e, m, s stop_bits – 1, 2 stop bits			
K-Config Example			
Set baud rate to 9600, 8 data bits, parity to none and stop bit to 1: "#UART 9600,8,node,1",0x0D			

14.7.4.3 CBIN

Functions		Permission	Transparency
Set:	CBIN	End User	-
Get:	-	End User	-
Description		Syntax	
Set:	Configure USR Keypad communication parameters	#CBIN[SE]P0, P1, P2, P3, P4, P5, P6[CR]	
Get:	-	-	
Response			
~[nn]@CBIN[SE]P0, P1, P2, P3, P4, P5, P6[SE]OK[CR LF]			
Parameters			
<p>P0 – USR1, USR2 P1 – UART P2 – baud rate: 1200, 2400, 4800, 9600, 19200, 38400, 57600, 115200 P3 – data bits: 5 to 8 P4 – parity: none, odd, even, mark, space, n, o, e, m, s P5 – stop bits: 1, 2 P6 – destination: PT, DATA, IN1, IN2, OUT1, OUT2, ALL, NONE, where PT=port tunneling and DATA= RS-232 DATA port</p>			
K-Config Example			
Set USR1 Keypad, UART, 9600,8,none,1 to port tunneling destination: "#CBIN USR1, UART, 9600, 8, n, 1, PT", 0x0D			

14.7.4.4 DBIN

Functions		Permission	Transparency
Set:	DBIN	End User	-
Get:	-	End User	-
Description		Syntax	
Set:	Program USR Keypad command	#DBIN[SE]P0, P1, [START TOKEN]P2[END TOKEN]CR	
Get:	-	-	
Response			
~[nn]@DBIN[SE]P0, P1[SE]OK[CR LF]			
Parameters			
<p>P0 – USR Keypad: USR1, USR2 P1 – 1 to 1024: set command byte numbers [START TOKEN] = "[" = HEX 5B = 0x5B P2 – command data (binary) [END TOKEN] = "]" = HEX 5D = 0x5D</p>			
K-Config Example			
Program USR1 Keypad to a 4-byte command (0x01, 0x82, 0x80, 0x81): "#DBIN USR1, 4, [", 0x01, 0x82, 0x80, 0x81, "]"", 0x0D			

14.7.4.5 BIN

Functions		Permission	Transparency
Set:	BIN	End User	-
Get:	-	End User	
Description		Syntax	
Set:	Launch USR Keypad command	#BIN	SP P0, P1, P2, START_TOKEN P3 END_TOKEN CR
Get:	14.7.4.514.7.4.5		
Response			
~r@BIN SP P0, P1, P2 SP OK CR LF			
Parameters			
<p>P0 – USR keypad: USR1, USR2</p> <p>P1 – UART</p> <p>P2 – when -1=launch USR command data as programmed (see DBIN Section 14.7.4.4) or when 1 to 1024=set byte numbers of one-time custom command</p> <p>START_TOKEN = “[“ = HEX 5B = 0x5B</p> <p>P3 – one-time custom command data (binary)</p> <p>END_TOKEN = “]” = HEX 5D = 0x5D</p>			
Notes			
<p>The BIN command can be used to launch the DBIN programmed command (P2=-1) or to launch a one-time custom command that overrides DBIN programmed command (P2=1-1024).</p> <p>When P2 is set to -1, BIN command syntax is complete.</p> <p>When P2 is set to 1 to 1024, P3 and its tokens are mandatory to the BIN command syntax</p>			
K-Config Examples			
<p>Launch USR1 Keypad programmed command:</p> <pre>"#BIN USR1, UART, -1", 0x0D</pre> <p>Launch one-time custom command (6-byte; 0x01, 0x82, 0x80, 0x81, 0x50, 0x71 command) using USR1 Keypad configuration (CBIN, see Section 14.7.4.3):</p> <pre>"#BIN USR1, UART, 6, [", 0x01, 0x82, 0x80, 0x81, 0x50, 0x71, "]"", 0x0D</pre>			

14.7.5 Audio Commands

Command	Description
AUD-LVL	Set/get input/output volume
VOLUME	Set the audio level
MUTE	Set/get audio mute

14.7.5.1 AUD-LVL

Functions		Permission	Transparency
Set:	AUD-LVL	End User	-
Get:	AUD-LVL?	End User	Audio
Description		Syntax	
Set:	Set audio level in specific amplifier stage	#AUD-LVL[SE]P1, P2, P3[CR]	
Get:	Get audio level in specific amplifier stage	#AUD-LVL?[SE]P1, P2[CR]	
Response			
~[nn]@AUD-LVL[SE]P1, P2[SF]OK[CR LF]			
Parameters			
<p>P1 – Input and Output: Input=0, Output=1</p> <p>P2– Audio Inputs (P1=0): 0~7; Audio Outputs (P1=1): CH 1=0, CH 2=1 Note that you can choose an input channel or the output, based on the selected P1.</p> <p>P3 – -80 to 20 (audio level) minus sign precedes negative values. ++ increase current value, -- decrease current value</p>			
K-Config Example			
Set the input 3 AUD-LVL to 75: "#AUD-LVL 0, 3, 75", 0x0D			

14.7.5.2 VOLUME

Functions		Permission	Transparency
Set:	VOLUME	End User	-
Get:	VOLUME?	End User	Audio
Description		Syntax	
Set:	Set volume	#VOLUME[SE]P1[CR]	
Get:	Get volume	#VOLUME?[SE]P1[CR]	
Response			
~[nn]@VOLUME[SE]P1[SF]OK[CR LF]			
Parameters			
<p>P1 – -80 to 20 (audio level) minus sign precedes negative values. ++ increase current value, -- decrease current value</p>			
K-Config Example			
Set the output volume to 75: "#VOLUME 75", 0x0D			

14.7.5.3 MUTE

Functions		Permission	Transparency
Set:	MUTE	End User	-
Get:	MUTE?	End User	Audio
Description		Syntax	
Set:	Set audio mute	#MUTE _{SE} channel,mute_mode _{CR}	
Get:	Get audio mute	#MUTE? _{SE} channel _{CR}	
Response			
~nn@MUTE _{SE} channel,mute_mode _{SE} OK _{CR} LF			
Parameters			
channel –Output number: Channel 1=0, Channel 2=1			
mute_mode – mute status: Off=0, On=1			
K-Config Example			
Set channel 2 mute to on: `#MUTE 1,1",0x0D			

14.7.6 Video Commands

Command	Description
VMUTE	Enable/disable video on output

14.7.6.1 VMUTE

Functions		Permission	Transparency
Set:	VMUTE	End User	-
Get:	VMUTE?	End User	Audio
Description		Syntax	
Set:	Set enable/disable video on output	#VMUTE _{SE} output_id,flag _{CR}	
Get:	Get video on output status	#VMUTE? _{SE} output_id _{CR}	
Response			
~nn@VMUTE _{SE} output_id,flag _{SE} OK _{CR} LF			
Parameters			
output_id –Output number: Channel 1=0, Channel 2=1			
flag – video mute status: Off=0, On=1			
K-Config Example			
Set channel 1 video mute to on: `#MUTE 0,1",0x0D			

The warranty obligations of Kramer Electronics Inc. ("Kramer Electronics") for this product are limited to the terms set forth below.

What is Covered

This limited warranty covers defects in materials and workmanship in this product.

What is Not Covered

This limited warranty does not cover any damage, deterioration or malfunction resulting from any alteration, modification, improper or unreasonable use or maintenance, misuse, abuse, accident, neglect, exposure to excess moisture, fire, improper packing and shipping (such claims must be presented to the carrier), lightning, power surges, or other acts of nature. This limited warranty does not cover any damage, deterioration or malfunction resulting from the installation or removal of this product from any installation, any unauthorized tampering with this product, any repairs attempted by anyone unauthorized by Kramer Electronics to make such repairs, or any other cause which does not relate directly to a defect in materials and/or workmanship of this product. This limited warranty does not cover cartons, equipment enclosures, cables or accessories used in conjunction with this product. Without limiting any other exclusion herein, Kramer Electronics does not warrant that the product covered hereby, including, without limitation, the technology and/or integrated circuit(s) included in the product, will not become obsolete or that such items are or will remain compatible with any other product or technology with which the product may be used.

How Long this Coverage Lasts

The standard limited warranty for Kramer products is seven (7) years from the date of original purchase, with the following exceptions:

1. All Kramer VIA products are covered by a standard three (3) year warranty for VIA hardware and a standard one (1) year warranty for firmware and software updates. (An extended software warranty plan for an additional 2 years can be purchased separately).
2. All Kramer fiber optic cables and adapters, all Kramer speakers and Kramer touch panels are covered by a standard one (1) year warranty.
3. All Kramer Cobra products, all Kramer Calibre products, all Kramer MiniCom digital signage products, all HighSeclabs products, all streaming, and all wireless products are covered by a standard three (3) year warranty.
4. All Sierra Video MultiViewers are covered by a standard five (5) year warranty.
5. Sierra switchers & control panels are covered by a standard seven (7) year warranty (excluding power supplies and fans that are covered for three (3) years).
6. K-Touch software is covered by a standard one (1) year warranty for software updates.
7. All Kramer passive cables are covered by a ten (10) year warranty.

Who is Covered

Only the original purchaser of this product is covered under this limited warranty. This limited warranty is not transferable to subsequent purchasers or owners of this product.

What Kramer Electronics Will Do

Kramer Electronics will, at its sole option, provide one of the following three remedies to whatever extent it shall deem necessary to satisfy a proper claim under this limited warranty.

1. Elect to repair or facilitate the repair of any defective parts within a reasonable period of time, free of any charge for the necessary parts and labor to complete the repair and restore this product to its proper operating condition. Kramer Electronics will also pay the shipping costs necessary to return this product once the repair is complete.
2. Replace this product with a direct replacement or with a similar product deemed by Kramer Electronics to perform substantially the same function as the original product.
3. Issue a refund of the original purchase price less depreciation to be determined based on the age of the product at the time remedy is sought under this limited warranty.

What Kramer Electronics Will Not Do Under This Limited Warranty

If this product is returned to Kramer Electronics or the authorized dealer from which it was purchased or any other party authorized to repair Kramer Electronics products, this product must be insured during shipment, with the insurance and shipping charges prepaid by you. If this product is returned uninsured, you assume all risks of loss or damage during shipment. Kramer Electronics will not be responsible for any costs related to the removal or re-installation of this product from or into any installation. Kramer Electronics will not be responsible for any costs related to any setting up this product, any adjustment of user controls or any programming required for a specific installation of this product.

How to Obtain a Remedy Under This Limited Warranty

To obtain a remedy under this limited warranty, you must contact either the authorized Kramer Electronics reseller from whom you purchased this product or the Kramer Electronics office nearest you. For a list of authorized Kramer Electronics resellers and/or Kramer Electronics authorized service providers, visit our web site at www.kramerav.com or contact the Kramer Electronics office nearest you.

In order to pursue any remedy under this limited warranty, you must possess an original, dated receipt as proof of purchase from an authorized Kramer Electronics reseller. If this product is returned under this limited warranty, a return authorization number, obtained from Kramer Electronics, will be required (RMA number). You may also be directed to an authorized reseller or a person authorized by Kramer Electronics to repair the product.

If it is decided that this product should be returned directly to Kramer Electronics, this product should be properly packed, preferably in the original carton, for shipping. Cartons not bearing a return authorization number will be refused.

Limitation of Liability

THE MAXIMUM LIABILITY OF KRAMER ELECTRONICS UNDER THIS LIMITED WARRANTY SHALL NOT EXCEED THE ACTUAL PURCHASE PRICE PAID FOR THE PRODUCT. TO THE MAXIMUM EXTENT PERMITTED BY LAW, KRAMER ELECTRONICS IS NOT RESPONSIBLE FOR DIRECT, SPECIAL, INCIDENTAL OR CONSEQUENTIAL DAMAGES RESULTING FROM ANY BREACH OF WARRANTY OR CONDITION, OR UNDER ANY OTHER LEGAL THEORY. Some countries, districts or states do not allow the exclusion or limitation of relief, special, incidental, consequential or indirect damages, or the limitation of liability to specified amounts, so the above limitations or exclusions may not apply to you.

Exclusive Remedy

TO THE MAXIMUM EXTENT PERMITTED BY LAW, THIS LIMITED WARRANTY AND THE REMEDIES SET FORTH ABOVE ARE EXCLUSIVE AND IN LIEU OF ALL OTHER WARRANTIES, REMEDIES AND CONDITIONS, WHETHER ORAL OR WRITTEN, EXPRESS OR IMPLIED. TO THE MAXIMUM EXTENT PERMITTED BY LAW, KRAMER ELECTRONICS SPECIFICALLY DISCLAIMS ANY AND ALL IMPLIED WARRANTIES, INCLUDING, WITHOUT LIMITATION, WARRANTIES OF MERCHANTABILITY AND FITNESS FOR A PARTICULAR PURPOSE. IF KRAMER ELECTRONICS CANNOT LAWFULLY DISCLAIM OR EXCLUDE IMPLIED WARRANTIES UNDER APPLICABLE LAW, THEN ALL IMPLIED WARRANTIES COVERING THIS PRODUCT, INCLUDING WARRANTIES OF MERCHANTABILITY AND FITNESS FOR A PARTICULAR PURPOSE, SHALL APPLY TO THIS PRODUCT AS PROVIDED UNDER APPLICABLE LAW.

IF ANY PRODUCT TO WHICH THIS LIMITED WARRANTY APPLIES IS A "CONSUMER PRODUCT" UNDER THE MAGNUSON-MOSS WARRANTY ACT (15 U.S.C.A. §2001, ET SEQ.) OR OTHER APPLICABLE LAW, THE FOREGOING DISCLAIMER OF IMPLIED WARRANTIES SHALL NOT APPLY TO YOU, AND ALL IMPLIED WARRANTIES ON THIS PRODUCT, INCLUDING WARRANTIES OF MERCHANTABILITY AND FITNESS FOR THE PARTICULAR PURPOSE, SHALL APPLY AS PROVIDED UNDER APPLICABLE LAW.

Other Conditions

This limited warranty gives you specific legal rights, and you may have other rights which vary from country to country or state to state.

This limited warranty is void if (i) the label bearing the serial number of this product has been removed or defaced, (ii) the product is not distributed by Kramer Electronics or (iii) this product is not purchased from an authorized Kramer Electronics reseller. If you are unsure whether a reseller is an authorized Kramer Electronics reseller, visit our web site at www.kramerav.com or contact a Kramer Electronics office from the list at the end of this document.

Your rights under this limited warranty are not diminished if you do not complete and return the product registration form or complete and submit the online product registration form. Kramer Electronics thanks you for purchasing a Kramer Electronics product. We hope it will give you years of satisfaction.



For the latest information on our products and a list of Kramer distributors, visit our Web site where updates to this user manual may be found.

We welcome your questions, comments, and feedback.

Web site: www.Kramerav.com

E-mail: info@kramerel.com



SAFETY WARNING

Disconnect the unit from the power supply before opening and servicing



P/N: 2900-300445



Rev: 1