



ALG

Live Events

HIRER CATALOGUE

PA SYSTEMS - STAGE LIGHTING - STAGING - TRUSSING - EVENT HIRE

WWW.ALG-UK.COM

ALL PRICES SUBJECT TO DISCOUNTS & EXCLUDE VAT

0121 458 4457

INFO@ALG-UK.COM

0791 876 5593

PROFESSIONAL EQUIPMENT HIRE

ALG ALWAYS SUPPLIES HIGH QUALITY EQUIPMENT AND EXCELLENT CUSTOMER SERVICE TO ENSURE YOUR FUNCTION IS A SUCCESS. WE SPECIALISE IN SOUND SYSTEM, AV, LIGHTING AND STAGING HIRE.

ALL OUR EQUIPMENT IS REGULARLY SERVICED AND IN EXCELLENT CONDITION, PAT TESTED FOR ELECTRICAL SAFETY AND WITH FULL PUBLIC/PRODUCT LIABILITY INSURANCE.

LONG AND SHORT TERM HIRE CONTRACTS

WE CAN OFFER GREATLY DISCOUNTED MONTHLY RENTAL RATES ON EQUIPMENT. THE GREAT ADVANTAGE OF EQUIPMENT RENTAL FROM ALG IS THAT ALL MAINTENANCE COSTS ARE COVERED, SUCH AS LAMPS, MAINTENANCE, ALL INCLUDED IN THE HIRE PRICE.

TYPES OF HIRE AND SERVICES ALG PROVIDE

ASSISTED HIRE - DELIVERY-SETUP / BREAKDOWN-COLLECTION OF HIRE EQUIPMENT.

DRY HIRE - COLLECTED AND RETURNED BY THE HIRER

DELIVERY/COLLECTION SERVICE AVAILABLE

ENGINEERS AND CREW

24 HOURS CALL OUT

FOR MORE INFORMATION ON HIRE EQUIPMENT
AND BOOKINGS CONTACT 0121 454 4457
OR EMAIL: INFO@ALG-UK.COM

TRUSSING AND RIGGING

CONTENTS

TRUSSING
RIGGING

65
67



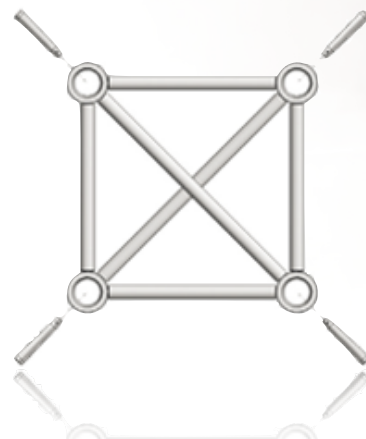
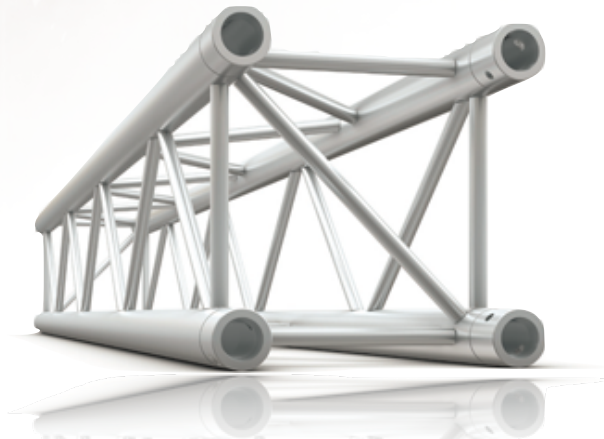

MILOS M290 QUATRO

DESCRIPTION	DAY	WEEK
3000 MM	£30.00	£90.00
2500 MM	£25.00	£75.00
2000 MM	£20.00	£60.00
1000 MM	£10.00	£30.00
710 MM	£10.00	£30.00
500 MM	£5.00	£15.00
290 MM	£5.00	£15.00

MILOS M290 QUATRO CORNERS AND ACCESSORIES

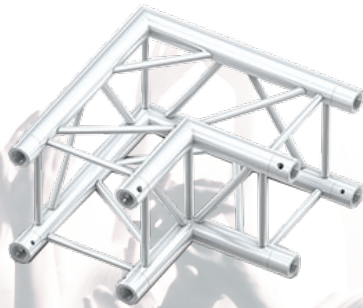

2-WAY CORNER

DAY: £15.00 WEEK: £45.00

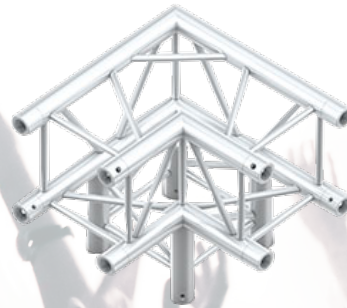

3-WAY CORNER

DAY: £15.00 WEEK: £45.00



3-WAY T

DAY: £15.00 WEEK: £45.00

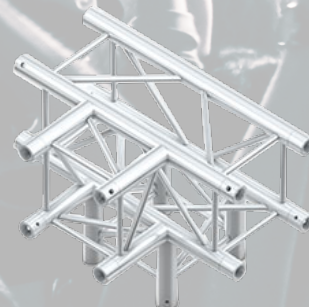

4-WAY T

DAY: £15.00 WEEK: £45.00

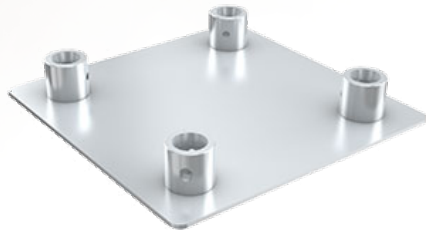

300MM X 300MM BASE PLATE

DAY: £8.00 WEEK: £24.00



600MM X 600MM BASE PLATE

DAY: £8.00 WEEK: £24.00



MULTICUBE

DAY: £18.00 WEEK: £54.00



CONICAL PIN AND SAFETY PIN

DAY: £0.50 WEEK: £1.50



MILOS M290 DUO



DESCRIPTION	DAY	WEEK
3000 MM	£15.00	£45.00
2000 MM	£10.00	£30.00
1000 MM	£5.00	£15.00

LIFTKET 1 TON ELECTRIC CHAIN HOIST

LOAD CAPACITY: 1000 KG (1 TON)
LIFT HEIGHT: 20 METERS
LIFTING SPEED: APPROX. 4 M PER MINUTE
ELECTRICITY SUPPLY: 400 V - THREE PHASE - 50 HZ
CONTROL TYPE: DIRECT DRIVE
PROTECTION: IP 54
DIMENSIONS (LXWXH): 413 MM X 275 MM X 221 MM
WEIGHT WITH CHAIN: 29 KG
WEIGHT WITH CHAIN: 49 KG

DAY: £50.00 WEEK: £150.00



FANTEK T-107 TOWER LIFT 325 KG

SECTIONS: 5
TELESCOPIC'S: 4
MATERIAL: ALUMINIUM
MAX. HEIGHT: 7.0 M
MIN. HEIGHT: 1.90 M
MIN. LOAD HEIGHT: 0.20 M
MAX. LOAD: 325 KG
MIN. LOAD: 25 KG
FOOTPRINT UNFOLDED 2.25X 2.0 M
FOOTPRINT FOLDED 0.5 X 0.5 M
WEIGHT: 175 KG
CERTIFICATION IN ACCORDANCE WITH: CE, BGV-C1

DAY: £80.00 WEEK: £240.00





4 CHANNEL CHAIN HOIST CONTROLLER

DAY: £20.00 WEEK: £60.00



1 TON STEEL SPAN SET

2 MTR - DAY: £2.50 WEEK: £7.50



2 TON ROUND SLING

0.5 M - DAY: £2.50 WEEK: £7.50
1 M - DAY: £2.50 WEEK: £7.50
2 M - DAY: £2.50 WEEK: £7.50

SHACKLES

1 TON - DAY: £2.00 WEEK: £6.00
2 TON - DAY: £2.50 WEEK: £7.50



TERMS AND CONDITIONS

1. DEFINITIONS AND LAW

- 1.1. "THE EQUIPMENT" SHALL MEAN GOODS, COMPONENTS AND OTHER ITEMS HIRED OR SOLD BY ALG LIVE EVENTS LTD. OR ANY PART THEREOF
- 1.2. "THE CUSTOMER" IS THE PERSON, RM, CORPORATE OR PUBLIC BODY HIRING OR PURCHASING THE EQUIPMENT. ANY PERSON PURPORTING TO ACT ON BEHALF OF THE CUSTOMER SHALL BE BOUND BY THE CONTRACT
- 1.3. "CONSEQUENTIAL LOSS" SHALL MEAN LOSS OF PROFITS, CONTRACTS OR OTHER CONSEQUENTIAL LOSS OR DAMAGES WHATSOEVER
- 1.4. "INTEREST" SHALL MEAN INTEREST CALCULATED IN ACCORDANCE WITH CLAUSE 4.1
- 1.5. THE CONTRACT SHALL BE INTERPRETED AND APPLIED IN ACCORDANCE WITH ENGLISH LAW AND THE PARTIES TO THIS CONTRACT AGREE TO SUBMIT TO THE EXCLUSIVE JURISDICTION OF THE ENGLISH COURTS

2. HIRE TERMS

2.1. CHARGES

- 2.1.1. HIRE CHARGES COMMENCE FROM THE DATE STATED IN THE CONTRACT AND ARE PAYABLE FOR THE PERIOD OF HIRE
- 2.1.2. EQUIPMENT MUST BE RETURNED BY 12 NOON ON THE DATE SPECIFIED IN THE CONTRACT IN A CLEAN AND SERVICEABLE CONDITION AND THE CUSTOMER MUST OBTAIN THE SUPPLIER'S RECEIPT
- 2.1.3. ADDITIONAL CHARGES ACCRUE AT THE FULL DAILY HIRE RATE TOGETHER WITH CONSEQUENTIAL LOSS IN THE EVENT OF THE BREACH OF THESE CONDITIONS OR THE EQUIPMENT NOT BEING AVAILABLE FOR USE BY OTHER CUSTOMERS
- 2.1.4. ALL CABLES MUST BE RETURNED COILED AND TAPED AND IN DEFAULT A CHARGE OF £2 PER CABLE WILL BE MADE
- 2.1.5. ALG LIVE EVENTS LTD. PROVIDES SPARE LAMPS AND FUSES WITH EQUIPMENT WHERE APPROPRIATE. THESE AND ANY LAMPS AND FUSES THEY REPLACE MUST BE RETURNED WITH THE EQUIPMENT AND IN DEFAULT THEIR FULL REPLACEMENT COST WILL BE CHARGED
- 2.1.6. ALL CHARGES ARE PAYABLE ON DEMAND

2.2. HIRE PERIOD

- 2.2.1. THE HIRING PERIOD COMMENCES AT 12 NOON ON THE DATE SPECIFIED IN THE CONTRACT AND CONTINUES FOR THE PERIOD SPECIFIED IN THE CONTRACT AND TERMINATES AT 12 NOON ON THE LAST DAY OF THE HIRING PERIOD

2.3. POWER TO ENTER THIS CONTRACT

- 2.3.1. THE SIGNATORY TO THE CONTRACT WARRANTS THAT THEY ARE DULY AUTHORISED ON THE CUSTOMER'S BEHALF TO ENTER INTO THE CONTRACT AND HEREBY PERSONALLY INDEMNIFIES ALG LIVE EVENTS LTD. AGAINST ALL LOSSES AND COSTS THAT MAY BE INCURRED BY ALG LIVE EVENTS LTD. IF THIS IS NOT THE CASE

2.4. CUSTOMER'S RESPONSIBILITIES

- 2.4.1. THE CUSTOMER'S RESPONSIBILITY FOR THE EQUIPMENT COMMENCES ON RECEIPT OF THE EQUIPMENT BY THE CUSTOMER OR HIS AGENT OR ON DELIVERY AND ENDS WHEN THE CUSTOMER IS IN POSSESSION OF ALG LIVE EVENTS LTD'S UNQUALIFIED RECEIPT FOR THE RETURN OF ALL THE EQUIPMENT
- 2.4.2. THE CUSTOMER SHALL NOT AT ANY TIME SELL DISPOSE OR OTHERWISE PART WITH CONTROL OF THE EQUIPMENT OR ATTEMPT TO DO SO
- 2.4.3. THE SIGNATORY TO THE CONTRACT AND THE CUSTOMER JOINTLY AND SEVERALLY UNDERTAKE WITH ALG LIVE EVENTS LTD. THAT EVERYONE WHO USES THE EQUIPMENT HAS BEEN PROPERLY INSTRUCTED IN ITS SAFE AND PROPER OPERATION AND WILL ENSURE THAT EVERY USER IS IN POSSESSION OF NECESSARY INSTRUCTIONAL MATERIAL AND FURTHER WILL NOT ALLOW THE EQUIPMENT TO BE MISUSED
- 2.4.4. THE CUSTOMER WILL AT ALL TIMES FULLY INDEMNIFY ALG LIVE EVENTS LTD. AGAINST ANY EXPENSE LIABILITY FINANCIAL LOSS CLAIM OR PROCEEDINGS WHATSOEVER IN RESPECT OF ANY PERSONAL INJURY OR DAMAGE TO OR LOSS OF ANY PROPERTY ARISING OUT OF OR IN CONNECTION WITH THE DELIVERY HIRE USE NON USE REPOSSESSION COLLECTION RETURN OR NON RETURN OF THE EQUIPMENT
- 2.4.5. NOTHING IN THIS CLAUSE SHALL AFFECT THE STATUTORY RIGHTS OF THE CUSTOMERS OR PURPORT TO EXCLUDE ANY LIABILITY WHICH MAY NOT BE EXCLUDED UNDER THE UNFAIR CONTRACT TERMS ACT 1977

2.5 ELECTRICAL EQUIPMENT

- 2.5.1. ANY ELECTRICAL EQUIPMENT SHOULD BE USED WITH PLUGS AND/OR SOCKETS AS FITTED
- 2.5.2. IF OTHER PLUGS OR SOCKETS ARE TO BE FITTED BY THE CUSTOMER SUCH WORK SHALL BE CARRIED OUT BY A COMPETENT PERSON WHO SHALL ALSO REINSTATE THE SAME TO THE ORIGINAL CONDITION PRIOR TO REDELIVERY
- 2.5.3. THE CUSTOMER SHALL BE RESPONSIBLE AT ALL TIMES TO ARRANGE A PROPER SUPPLY OF ELECTRICITY FOR USE WITH THE EQUIPMENT AND ENSURE THAT THE EQUIPMENT SHALL AT ALL TIMES BE PROPERLY EARTHED

2.6. EQUIPMENT MAINTENANCE AND REPORTING

- 2.6.1. THE CUSTOMER SHALL ENSURE THAT THE EQUIPMENT REMAINS SERVICEABLE AND CLEAN DURING THE HIRE PERIOD
- 2.6.2. ANY BREAKDOWN OR UNSATISFACTORY WORKING OF EQUIPMENT SHALL BE IMMEDIATELY NOTIFIED TO ALG LIVE EVENTS LTD.
- 2.6.3. THE CUSTOMER SHALL UNDER NO CIRCUMSTANCES ATTEMPT TO REPAIR THE EQUIPMENT WITHOUT PRIOR AUTHORISATION FROM ALG LIVE EVENTS LTD.
- 2.6.4. ANY DAMAGED OR UNSATISFACTORY EQUIPMENT MUST BE RETURNED TO ALG LIVE EVENTS LTD'S PREMISES FOR EXAMINATION AT THE CUSTOMER'S COST

- 2.6.5. IF THE EQUIPMENT IS INVOLVED IN ANY ACCIDENT RESULTING IN DAMAGE TO EITHER THE EQUIPMENT OR OTHER PROPERTY OR INJURY TO ANY PERSON THE CUSTOMER SHALL NOTIFY ALG LIVE EVENTS LTD. IMMEDIATELY

- 2.6.6. EQUIPMENT MUST NOT BE REMOVED FROM ANY SITE ORIGINALLY SPECIFIED BY THE CUSTOMER OR FROM ANY SUBSEQUENTLY AUTHORISED SITE WITHOUT PRIOR CONSENT OF ALG LIVE EVENTS LTD.

2.7. COMPATIBILITY OF EQUIPMENT

- 2.7.1. THE CUSTOMER SHALL ENSURE THAT THE EQUIPMENT IS COMPATIBLE AND MAY SAFELY BE USED WITH ANY OTHER EQUIPMENT BEING USED BY THE CUSTOMER
- 2.7.2. THE CUSTOMER SHALL BE RESPONSIBLE FOR ENSURING THAT ANY EQUIPMENT IS SUITABLE FOR THEIR PURPOSES

2.8 INSURANCE

- 2.8.1. THE CUSTOMER AGREES TO PAY ALG LIVE EVENTS LTD. THE FULL RETAIL COST OF ANY EQUIPMENT LOST STOLEN OR DAMAGE BEYOND ECONOMIC REPAIR (WITHOUT DEDUCTION FOR USAGE WEAR TEAR OR AGE)
- 2.8.2. THE CUSTOMER SHALL INSURE THE GOODS AGAINST THE ABOVE LIABILITY
- 2.8.3. ALL MONIES RECEIVED BY THE CUSTOMER FROM ANY INSURANCE COMPANY OR THIRD PARTY IN SETTLEMENT OF ANY CLAIM SHALL BE HELD IN TRUST BY THE CUSTOMER AND PAID TO ALG LIVE EVENTS LTD. ON DEMAND TO THE EXTENT THAT ANY SUCH PAYMENT IS DUE UNDER THIS CLAUSE
- 2.8.4. THE CUSTOMER SHALL NOT COMPROMISE OR SETTLE ANY CLAIM WITHOUT THE EXPRESS CONSENT OF ALG LIVE EVENTS LTD.

2.8.5. IN THE CASE OF EQUIPMENT WHICH IS LOST STOLEN OR DAMAGED BEYOND ECONOMIC REPAIR THE CUSTOMER SHALL PAY A CHARGE AT THE FULL DAILY RATE TOGETHER WITH INTEREST AND CONSEQUENTIAL LOSS UNTIL THE EQUIPMENT IS REPLACED

2.9. CONDITION OF RETURNED EQUIPMENT

2.9.1. THE CUSTOMER IS FULLY RESPONSIBLE FOR CARE SAFE KEEPING AND RETURN IN GOOD ORDER OF THE EQUIPMENT

2.9.2. THE CUSTOMER WILL REIMBURSE ALL COSTS INCURRED BY ALG LIVE EVENTS LTD. IN RECTIFYING THE CONDITION OF ANY EQUIPMENT RETURNED DAMAGED OR UNCLEAN AND SHALL IN ADDITION PAY A CHARGE AT THE FULL DAILY HIRE RATE TOGETHER WITH INTEREST AND ANY CONSEQUENTIAL LOSS UNTIL RECTIFICATION

2.10. TERMINATION OF HIRE

2.10.1. ALG LIVE EVENTS LTD. SHALL BE ENTITLED TO TERMINATE THE CONTRACT WITH IMMEDIATE EFFECT AND TO REPOSSESS THE EQUIPMENT IF AT ANY TIME:

(A) THE CUSTOMER IS IN BREACH OF THESE TERMS; OR

(B) THE CUSTOMER SHALL TAKE ANY STEPS OR IF ANY ACT OR PROCEEDING IS COMMENCED IN WHICH THE CUSTOMER'S SOLVENCY IS IN THE REASONABLE VIEW OF ALG LIVE EVENTS LTD. IN DOUBT. SUCH TERMINATION SHALL NOT AFFECT THE RIGHT OF ALG LIVE EVENTS LTD. TO RECOVER FROM THE CUSTOMER ANY MONIES DUE UNDER THIS CONTRACT INTEREST CONSEQUENTIAL LOSS OR DAMAGES FOR BREACH

2.10.2. THE CUSTOMER HEREBY AUTHORISES ALG LIVE EVENTS LTD. TO ENTER UPON ANY PROPERTY UPON WHICH ALG LIVE EVENTS LTD. REASONABLY BELIEVE ANY EQUIPMENT TO BE AND ALG LIVE EVENTS LTD. IN THEIR ABSOLUTE DISCRETION MAY RECOVER AND REMOVE THE EQUIPMENT

2.11. THE CUSTOMER HEREBY AUTHORISES ALG LIVE EVENTS LTD. (NOTWITHSTANDING ANY SUBSEQUENT INSTRUCTION TO THE CONTRARY AFTER THE DATE OF THE COMMENCEMENT OF THE CONTRACT) TO DEDUCT ANY SUMS PROPERLY DUE TO ALG LIVE EVENTS LTD. ARISING UNDER A BREACH OF THESE TERMS FROM ANY CREDIT CARD DEBIT CARD OR CHARGE ACCOUNT DETAILS OF WHICH ARE IN THE POSSESSION OF ALG LIVE EVENTS LTD.

3. CONDITIONS AS TO SALE

3.1. RISK IN TITLE

3.1.1. THE RISK IN THE EQUIPMENT SHALL PASS TO THE CUSTOMER IMMEDIATELY ON DELIVERY TO THE CUSTOMER AT THE ADDRESS SHOWN FOR DELIVERY ON THE CONTRACT OR IF THE CUSTOMER COLLECTS ON COLLECTION

3.1.2. PROPERTY AND TITLE IN THE EQUIPMENT SHALL REMAIN VESTED IN ALG LIVE EVENTS LTD. AND ALG LIVE EVENTS LTD. RESERVE THE RIGHT TO DISPOSE OF THE EQUIPMENT UNTIL SUCH TIME AS THE PRICE SHALL HAVE BEEN PAID IN FULL

3.1.3. IF ANY PART OF THE PAYMENT IS OVERDUE OR IF THE CUSTOMER IS IN BREACH OF ANY OF THESE TERMS OR IF THE CUSTOMER OR ANY THIRD PARTY SHALL TAKE ANY STEPS OR ANY ACT OR PROCEEDING IN WHICH IN THE REASONABLE VIEW OF ALG LIVE EVENTS LTD. THE CUSTOMER'S SOLVENCY IS IN DOUBT ALG LIVE EVENTS LTD. MAY (WITHOUT PREJUDICE TO ANY OF ALG LIVE EVENTS LTD.' OTHER RIGHTS) RECOVER OR RESELL THE EQUIPMENT AND MAY ENTER UPON THE CUSTOMER'S OR ANY THIRD PARTIES PROPERTY FOR THAT PURPOSE

3.2. RECEIPT

3.2.1. THE CUSTOMER OR ANY DULY AUTHORISED PERSON ON BEHALF OF THE CUSTOMER SHALL RECEIVE AND UNLOAD THE EQUIPMENT AND SHALL CHECK THE SAME FOR QUANTITY AND CONDITION IN THE PRESENCE OF ALG LIVE EVENTS LTD.' CARRIER

3.2.2. ANY SHORTAGE OF OR UNSATISFACTORY EQUIPMENT SHALL BE ENDORSED BY THE CUSTOMER OR A DULY AUTHORISED PERSON ON BEHALF OF THE CUSTOMER ON THE DELIVERY DOCUMENT AND THE CUSTOMER SHALL GIVE WRITTEN CONFIRMATION TO ALG LIVE EVENTS LTD. WITHIN THREE DAYS OF DELIVERY

3.2.3. NO CLAIM IN RESPECT OF SHORTAGE OF OR UNSATISFACTORY CONDITION OF THE EQUIPMENT SHALL BE ENTERTAINED BY ALG LIVE EVENTS LTD. UNLESS CONDITION

3.2.2. IS OBSERVED

3.2.4. THIS CONDITION DOES NOT AFFECT THE STATUTORY RIGHTS OF THE CUSTOMER

3.3. PRICE

3.3.1. THE PRICE CHARGED WILL BE THE PRICE RULING AT THE TIME OF DELIVERY. WHERE THIS IS AT VARIANCE WITH THE PRICE QUOTED OR INSERTED IN THE CONTRACT AT THE TIME THE GOODS WERE ORDERED THE CUSTOMER WILL BE ADVISED PRIOR TO DELIVERY

3.4. PAYMENT

3.4.1. WHERE ACCOUNT FACILITIES HAVE BEEN GRANTED TO THE CUSTOMER IN WRITING ALL INVOICES MUST BE PAID WITHIN 15 DAYS OF INVOICE DATE

3.4.2. WHERE NO SUCH FACILITIES HAVE BEEN GRANTED PAYMENT WILL BE WITH ORDER OR WHERE PREVIOUSLY AGREED ON DELIVERY

4. CONDITIONS APPLICABLE TO BOTH HIRE AND SALE

4.1. PAYMENT AND INTEREST

4.1.1. WHERE PAYMENTS ARE NOT MADE ON THE DUE DATE

ALG LIVE EVENTS LTD. WILL BE ENTITLED TO INTEREST ON THE AMOUNT THAT IS OVERDUE AT BARCLAYS BANK PLC BASE RATE PREVAILING FOR THE PERIOD FOR WHICH SUCH MONIES ARE OVERDUE TOGETHER WITH 4% CALCULATED ON A DAY TO DAY BASIS COMPOUNDED WITH QUARTERLY RESTS

4.1.2. THE PAYMENT OF SUCH INTEREST SHALL BE WITHOUT PREJUDICE TO ANY OTHER RIGHTS OR REMEDIES OF ALG LIVE EVENTS LTD.

4.1.3. ANY LEGAL OR OTHER CHARGES INCURRED IN THE RECOVERY OF MONEY OR EQUIPMENT SHALL BE PAID BY THE CUSTOMER

4.1.4. NOTWITHSTANDING ANY PROVISION IN THESE TERMS OF BUSINESS TO THE CONTRARY THE CUSTOMER SHALL IF REQUIRED BY ALG LIVE EVENTS LTD. PAY SUCH SUM ON ACCOUNT OF THE HIRE CHARGES OR PRICE FOR GOODS AND OR SERVICES AS SHALL BE AGREED AT THE TIME OF PLACING THE ORDER

4.2. LIABILITY

4.2.1. ALG LIVE EVENTS LTD.'S LIABILITY FOR ANY DEFECT IN THE EQUIPMENT SHALL BE LIMITED TO AND IN NO CASE EXCEED:

(A) ANY MANUFACTURER'S WARRANTY SOLD WITH THE EQUIPMENT; OR IF THERE SHALL BE NONE

(B) REPLACEMENT OR REPAIR OF THE DEFECTIVE EQUIPMENT; OR

(C) AT ALG LIVE EVENTS LTD.' OPTION A REFUND OF THE PRICE

4.2.2. CONSEQUENTIAL LOSSES

NOTHING IN THESE TERMS AND CONDITIONS SHALL MAKE ALG LIVE EVENTS LTD. LIABLE FOR ANY CONSEQUENTIAL LOSS TO THE CUSTOMER INCLUDING ANY EXPENSE LIABILITY LOSS CLAIM OR PROCEEDING WHATSOEVER CAUSED BY OR ARISING OUT OF THE LATE DELIVERY NON DELIVERY UNSUITABILITY INCOMPATIBILITY OR UNLAWFUL REPOSSESSION OF THE EQUIPMENT OR ANY PART THEREOF OR ANY BREAKDOWN OR STOPPAGE OF THE SAME

4.3. INJURY TO PERSONS AND DAMAGE TO PROPERTY

4.3.1. SUBJECT TO 4.2. ABOVE ALG LIVE EVENTS LTD. SHALL NOT BE LIABLE FOR ANY LOSS OTHER THAN THAT WHICH DIRECTLY ARISES FROM ANY INJURY TO PERSONS OR DAMAGE TO TANGIBLE PROPERTY WHERE AND ONLY TO THE EXTENT THAT SUCH INJURY OR DAMAGE IS CAUSED BY ANY DEFECTS IN THE EQUIPMENT AND WHERE SUCH DEFECT IS CAUSED BY THE NEGLIGENCE OF ALG LIVE EVENTS LTD.

4.4. RIGHTS RESERVED

4.4.1. ANY FAILURE BY ALG LIVE EVENTS LTD. TO ENFORCE ANY OR ALL OF THESE CONDITIONS SHALL NOT BE CONSTRUED AS A WAIVER OF ANY OF ALG LIVE EVENTS LTD.' RIGHTS HEREUNDER

4.4.2. IF ANY TERM IN THIS CONTRACT SHALL BE HELD INVALID SUCH INVALIDATION SHALL NOT AFFECT THE VALIDITY OF THE REMAINING TERMS

4.5. TERMS OF CONTRACT

4.5.1. THESE CONDITIONS HAVE EFFECT IN SUBSTITUTION FOR AND TO THE EXCLUSION OF ANY CONDITION PUT FORWARD BY THE CUSTOMER

4.6. DELIVERY AND CARRIAGE

4.6.1. ALL TIMES QUOTED OR STATED FOR DELIVERY ARE APPROXIMATE ONLY

4.6.2. HIRE CHARGES OR SALE PRICES DO NOT INCLUDE CARRIAGE. ANY EXPENSES INCURRED BY ALG LIVE EVENTS LTD. IN DELIVERY OR RECOVERING EQUIPMENT OR ATTEMPTING THE SAME WILL BE PAID BY THE CUSTOMER

4.6.3. WHERE CARRIAGE CHARGES ARE QUOTED BY ALG LIVE EVENTS LTD. SUCH CHARGES WILL INCLUDE ONLY FOR THE TIME TO LOAD OR UNLOAD ALONGSIDE THE ALG LIVE EVENTS LTD.' VEHICLE AT THE ADDRESS SPECIFIED BY THE CUSTOMER. FURTHER TIME OR ATTENDANCE WILL BE PAID FOR BY THE CUSTOMER

4.7. COPYRIGHT

4.7.1. ALG LIVE EVENTS LTD. NOTIFIES THE CUSTOMER THAT PLAYING OR SHOWING COPYRIGHT MATERIAL IN CIRCUMSTANCES WHERE THE CUSTOMER OR ANYONE AUTHORISED BY HIM DOES NOT HOLD THE APPROPRIATE LICENCE OF THE COPYRIGHT HOLDER HE WILL INFRINGE COPYRIGHT AND MAY BECOME LIABLE IN DAMAGES FOR SO DOING

4.7.2. THE CUSTOMER BY ACCEPTING DELIVERY OF SOUND OR VISUAL REPRODUCTION EQUIPMENT WARRANTS THAT HE HAS OR WILL OBTAIN THE APPROPRIATE LICENCE FOR THE SAID PERFORMANCE PLAYING OR SHOWING. PRIOR TO USING THE EQUIPMENT FOR THE SAID PURPOSE

FOR MORE INFORMATION CONTACT US:

**ALG LIVE EVENTS,
INGOT BUILDING, FIRST FLOOR
95 CHARLOTTE ROAD, STIRCHLEY, BIRMINGHAM,
B30 2BT
T: 0121 458 4457
F: 0121 459 2740 M: 0791 876 5593
E: INFO@ALG-UK.COM W: WWW.ALG-UK.COM**

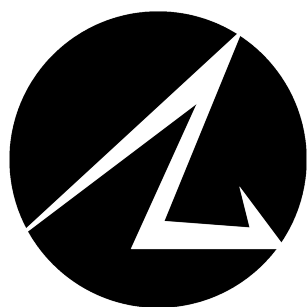

ALG

Live Events

ALG LIVE EVENTS,
INGOT BUILDING, FIRST FLOOR,
95 CHARLOTTE ROAD, STIRCHLEY, BIRMINGHAM,
B30 2BT

0121 458 4457

0791 876 5593

INFO@ALG-UK.COM

WWW.ALG-UK.COM

